

NCRP REPORT No. 147

Structural Shielding Design for Medical X-Ray Imaging Facilities

**Recommendations of the
NATIONAL COUNCIL ON RADIATION
PROTECTION AND MEASUREMENTS**

Issued November 19, 2004

Revised March 18, 2005

**National Council on Radiation Protection and Measurements
7910 Woodmont Avenue, Suite 400 / Bethesda, MD 20814**

LEGAL NOTICE

This Report was prepared by the National Council on Radiation Protection and Measurements (NCRP). The Council strives to provide accurate, complete and useful information in its documents. However, neither NCRP, the members of NCRP, other persons contributing to or assisting in the preparation of this Report, nor any person acting on the behalf of any of these parties: (a) makes any warranty or representation, express or implied, with respect to the accuracy, completeness or usefulness of the information contained in this Report, or that the use of any information, method or process disclosed in this Report may not infringe on privately owned rights; or (b) assumes any liability with respect to the use of, or for damages resulting from the use of any information, method or process disclosed in this Report, *under the Civil Rights Act of 1964, Section 701 et seq. as amended 42 U.S.C. Section 2000e et seq. (Title VII) or any other statutory or common law theory governing liability.*

Library of Congress Cataloging-in-Publication Data

Structural shielding design for medical X-ray imaging facilities.

p. cm. -- (NCRP report ; no. 147)

"October 2004."

Includes bibliographical references and index.

ISBN 0-929600-83-5

1. Radiology, Medical--Safety measures. 2. Shielding (Radiation) 3. Hospitals--Radiological services--Shielding (Radiation) I. National Committee on Radiation Protection (U.S.) II. Series.

R920.S77 2004

616.07'57'0289--dc22

2004022334

Copyright © National Council on
Radiation Protection and Measurements 2004

All rights reserved. This publication is protected by copyright. No part of this publication may be reproduced in any form or by any means, including photocopying, or utilized by any information storage and retrieval system without written permission from the copyright owner, except for brief quotation in critical articles or reviews.

[For detailed information on the availability of NCRP publications see page 173.]

Preface

This Report was developed under the auspices of Program Area Committee 2 of the National Council on Radiation Protection and Measurements (NCRP), the committee that is concerned with operational radiation safety. The Report addresses the structural shielding design for medical x-ray imaging facilities and supersedes the parts that address such facilities in NCRP Report No. 49, *Structural Shielding Design and Evaluation for Medical Use of X Rays and Gamma Rays of Energies Up to 10 MeV*, which was issued in September 1976. A second NCRP report is in preparation under the auspices of Program Area Committee 2 that will update the parts of NCRP Report No. 49 that address structural shielding design for megavoltage radiotherapy facilities using x and gamma rays.

This Report was prepared through a joint effort of NCRP Scientific Committee 9 on this subject and the American Association of Physicists in Medicine (AAPM). NCRP gratefully acknowledges the financial support of AAPM, the many opportunities that were made available for Scientific Committee 9 to meet at AAPM annual meetings, and the technical reviews of the Report provided by a number of specialists in radiation shielding. Serving on Scientific Committee 9 were:

Co-Chairmen

Benjamin R. Archer
Baylor College of Medicine
Houston, Texas

Joel E. Gray
Landauer, Inc.
Glenwood, Illinois

Members

Robert L. Dixon
Wake Forest University
School of Medicine
Winston-Salem,
North Carolina

William R. Eide, Jr.
Healthcare Planning
Consultant
Houston, Texas

Lincoln B. Hubbard
Hubbard, Broadbent
and Associates
Downers Grove, Illinois

Eric E. Kearsley
Silver Spring, Maryland

Robert M. Quillin
Centennial, Colorado

Raymond P. Rossi*
University of Colorado
Health Sciences Center
Denver, Colorado

Douglas R. Shearer
Rhode Island Hospital
Providence, Rhode Island

Douglas J. Simpkin
St. Luke's Medical Center
Milwaukee, Wisconsin

Consultants

Kenneth R. Kase
Stanford Linear
Accelerator Center
Menlo Park, California

Jack S. Krohmer*
Georgetown, Texas

Andrew K. Poznanski
The Children's Memorial
Hospital
Chicago, Illinois

Wayne L. Thompson
University of Tennessee
Medical Center
Knoxville, Tennessee

NCRP Secretariat

Marvin Rosenstein, *Consultant* (2001–2004)

Eric E. Kearsley, *Consultant* (1998–2001)

James A. Spahn, Jr., *Senior Staff Scientist* (1992–1998)

Cindy L. O'Brien, *Managing Editor*

David A. Schauer, *Executive Director*

The Council wishes to express its appreciation to the Committee members for the time and effort devoted to the preparation of this Report. This publication was made possible, in part, by Grant number R24 CA74296-07 from the National Cancer Institute (NCI) and its contents are the sole responsibility of NCRP and do not necessarily represent the official views of the NCI, National Institutes of Health.

Thomas S. Tenforde
President

*deceased

The National Council on Radiation Protection
and Measurements proudly dedicates
Report No 147, *Structural Shielding Design for
Medical X-Ray Imaging Facilities* to

Lauriston S. Taylor
Honorary President

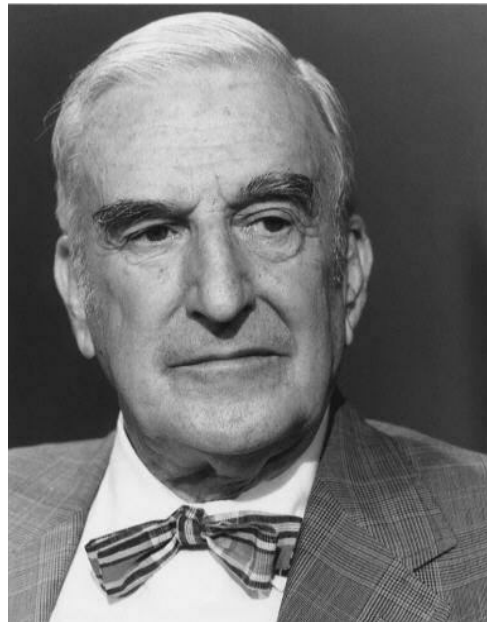

In recognition of five decades of service
to NCRP and the nation
and in celebration of his 102nd birthday.

Contents

Preface	iii
1. Introduction and Recommendations	1
1.1 Purpose and Scope	1
1.2 Quantities and Units	1
1.3 Controlled and Uncontrolled Areas	2
1.4 Shielding Design Goals for Medical X-Ray Imaging Facilities and Effective Dose	3
1.4.1 Controlled Areas	4
1.4.2 Uncontrolled Areas	4
1.4.3 Shielding Design Assumptions	5
1.4.4 Air-Kerma Limits for Radiographic Films	7
1.5 General Concepts	7
2. Fundamentals of Shielding for Medical X-Ray Imaging Facilities	9
2.1 Basic Principles	9
2.2 Types of Medical X-Ray Imaging Facilities	10
2.2.1 Radiographic Installations	10
2.2.2 Fluoroscopic Installations	11
2.2.3 Interventional Facilities	12
2.2.4 Dedicated Chest Installations	13
2.2.5 Mammographic Installations (Permanent and Mobile)	13
2.2.6 Computed Tomography Installations	14
2.2.7 Mobile Radiography and Fluoroscopy X-Ray Units	14
2.2.8 Dental X-Ray Facilities	15
2.2.9 Bone Mineral Measurement Equipment	15
2.2.10 Veterinary X-Ray Facilities	15
2.2.11 Other X-Ray Imaging Systems	15
2.3 Shielding Design Elements	16
2.3.1 Interior Walls	16
2.3.1.1 Sheet Lead	16
2.3.1.2 Gypsum Wallboard	16
2.3.1.3 Other Materials	17

2.3.2	Exterior Building Walls	18
2.3.3	Doors	18
2.3.3.1	Lead-Lined Doors	18
2.3.3.2	Wooden Doors	18
2.3.3.3	Door Interlocks, Warning Lights, and Warning Signs	19
2.3.4	Windows	19
2.3.4.1	Lead Glass	20
2.3.4.2	Plate Glass	20
2.3.4.3	Lead Acrylic	20
2.3.5	Floors and Ceilings	20
2.3.5.1	Standard-Weight Concrete	20
2.3.5.2	Light-Weight Concrete	21
2.3.5.3	Floor Slab Construction	21
2.3.6	Floor-to-Floor Heights	21
2.3.7	Interstitial Space	22
2.4	Shielding Design Considerations	22
2.4.1	Penetrations in Protective Barriers	22
2.4.2	Joints	23
2.5	Construction Standards	23
2.6	Dimensions and Tolerances	23
3.	Elements of Shielding Design	25
3.1	Strategic Shielding Planning	25
3.2	Project Development Process	25
3.2.1	Strategic Planning and Budgeting	26
3.2.2	Programming	27
3.2.3	Schematic (Preliminary) Design	27
3.2.4	Design Development	27
3.2.5	Construction Document Preparation	28
3.3	Documentation Requirements	28
4.	Computation of Medical X-Ray Imaging Shielding Requirements	29
4.1	Concepts and Terminology	29
4.1.1	Shielding Design Goals	29
4.1.2	Distance to the Occupied Area	29
4.1.3	Occupancy Factors	29
4.1.4	Workload and Workload Distribution	32
4.1.5	Use Factor	39

4.1.6	Primary Barriers	41
4.1.6.1	Unshielded Primary Air Kerma	42
4.1.6.2	Preshielding	43
4.1.7	Secondary Barriers	45
4.1.7.1	Leakage Radiation	45
4.1.7.2	Scattered Radiation	48
4.1.7.3	Total Contribution from Secondary Radiation	48
4.2	Shielding Calculation Methods	49
4.2.1	General Shielding Concepts	49
4.2.2	Shielding for Primary Barriers	50
4.2.3	Shielding for Secondary Barriers	51
4.2.4	Additional Method for Representative Radiographic Rooms, and Radiographic and Fluoroscopic Rooms	51
4.3	Uncertainties	67
5.	Examples of Shielding Calculations	69
5.1	Cardiac Angiography	72
5.2	Dedicated Chest Unit	73
5.3	The Radiographic Room	74
5.3.1	The Floor of the Radiographic Room	76
5.3.1.1	Primary Barrier Calculation for Floor Beneath the Radiographic Table	76
5.3.1.2	Secondary Barrier Calculation for Floor	77
5.3.2	The Ceiling of a Radiographic Room	78
5.3.3	Wall Containing the Chest Image Receptor in the Radiographic Room	79
5.3.3.1	Wall Containing the Chest Image Receptor in the Radiographic Room	79
5.3.3.2	Secondary Barrier: Chest Image- Receptor Wall	80
5.3.4	Darkroom Wall in the Radiographic Room	81
5.3.5	The Cross-Table Wall in the Radiographic Room	83
5.3.6	Control Wall in the Radiographic Room	85
5.4	Radiographic and Fluoroscopic Room	86
5.4.1	Secondary Barrier Calculation for the Floor in the Radiographic and Fluoroscopic Room	87

5.4.2	Primary Barrier Calculation for the Floor in the Radiographic and Fluoroscopic Room	89
5.5	Mammography	91
5.6	Computed Tomography	94
5.6.1	Dose-Length Product Method	97
5.6.2	The Isodose Map Method	100
5.6.3	Cautionary Notes	101
5.7	Bone Mineral Density Units (Dual Energy X-Ray Absorption Scanners)	101
5.8	Shielding Design Report	103
6.	Radiation Protection Surveys	104
6.1	Introduction	104
6.2	Inspection for Voids	104
6.3	Evaluation of Shielding Adequacy	106
6.3.1	Visual Inspection to Determine the Presence and Thickness of Radiation Barriers Before the Structure Has Been Completed	106
6.3.2	Transmission Measurements to Determine the Presence and Thickness of Radiation Barriers .	107
6.3.3	Determination of the Adequacy of Radiation Barriers	108
6.3.3.1	Primary Barrier: Chest-Buck Wall . . .	109
6.3.3.2	Secondary Barrier: Chest-Bucky Wall, Area Beyond Chest Bucky	110
6.3.3.3	Cross-Table Wall.	110
6.3.3.4	Secondary Barrier at Which it is Impossible to Aim Primary Beam	110
6.3.3.5	Floor	111
6.3.3.6	Summary.	111
6.3.4	Computed Tomography Scanner Survey.	111
6.4	Survey Report.	112
6.5	Problem Abatement	113
6.6	Documentation	115
	Appendix A. Transmission Data	116
	Appendix B. Computation of Primary Barrier Thickness	125
	Appendix C. Computation of Secondary Barrier Thickness	135
C.1	Scattered Radiation	135

C.2 Leakage Radiation	138
C.3 Total Secondary Barrier and Secondary Transmission	139
C.4 The General Case	142
Appendix D. Instrumentation for Performing Radiation Protection Surveys	149
Glossary	152
Symbols	157
References	160
The NCRP	164
NCRP Publications	173
Index	184

1. Introduction and Recommendations

1.1 Purpose and Scope

The purpose of radiation shielding is to limit radiation exposures to employees and members of the public to an acceptable level. This Report presents recommendations and technical information related to the design and installation of structural shielding for facilities that use x rays for medical imaging. This information supersedes the recommendations in NCRP Report No. 49 (NCRP, 1976) pertaining to medical diagnostic x-ray facilities. It includes a discussion of the various factors to be considered in the selection of appropriate shielding materials and in the calculation of barrier thicknesses. It is mainly intended for those individuals who specialize in radiation protection; however, this Report also will be of interest to architects, hospital administrators, and related professionals concerned with the planning of new facilities that use x rays for medical imaging.

Terms and symbols used in the Report are defined in the Glossary. Recommendations throughout this Report are expressed in terms of *shall* and *should* where:

- *shall* indicates a recommendation that is necessary to meet the currently accepted standards of radiation protection; and
- *should* indicates an advisory recommendation that is to be applied when practicable or practical (*e.g.*, cost effective).

1.2 Quantities and Units

The recommended quantity for shielding design calculations for x rays is *air kerma* (K),¹ defined as the sum of the initial kinetic energies of all the charged particles liberated by uncharged particles per unit mass of air, measured at a point in air (ICRU, 1998a).

¹In this Report, the symbol K always refers to the quantity air kerma (in place of the symbol K_a), followed by an appropriate subscript to further describe the quantity (*e.g.*, K_p , air kerma from primary radiation).

The unit of air kerma is joule per kilogram (J kg^{-1}), with the special name gray (Gy). However, many radiation survey instruments in the United States are currently designed and calibrated to measure the quantity exposure (ICRU, 1998a), using the previous special name roentgen (R). Exposure also can be expressed in the unit of coulomb per kilogram (C kg^{-1}) (ICRU, 1998a), referring to the amount of charge produced in air when all of the charged particles created by photons in the target mass of air are completely stopped in air. For the direct measurement of radiation protection quantities discussed in this Report, the result from an instrument calibrated for exposure (in roentgens) may be divided by 114 to obtain K (in gray). For instruments calibrated in roentgens and used to measure transmission factors for barriers around facilities that use x rays for medical imaging, no conversion is necessary because a transmission factor is the ratio of the same quantities.

The recommended radiation protection quantity for the limitation of exposure to people from sources of ionizing radiation is *effective dose* (E), defined as the sum of the weighted equivalent doses to specific organs or tissues [*i.e.*, each equivalent dose is weighted by the corresponding *tissue weighting factor* for the organ or tissue (w_T)] (NCRP, 1993). The value of w_T for a particular organ or tissue represents the fraction of detriment (*i.e.*, from cancer and hereditary effects) attributed to that organ or tissue when the whole body is irradiated uniformly. The *equivalent dose* to a specific organ or tissue (H_T) is obtained by weighting the mean absorbed dose in a tissue or organ (D_T) by a *radiation weighting factor* (w_R) to allow for the relative biological effectiveness of the ionizing radiation or radiations of interest. For the type of radiation considered in this Report (*i.e.*, x rays) w_R is assigned the value of one.

The National Council on Radiation Protection and Measurements (NCRP) has adopted the use of the International System (SI) of Units in its publications (NCRP, 1985). In addition, this Report will occasionally utilize both SI and non-SI units to describe certain characteristics for building materials, since non-SI units are in common use in the architectural community.

1.3 Controlled and Uncontrolled Areas

A controlled area is a limited access area in which the occupational exposure of personnel to radiation is under the supervision of an individual in charge of radiation protection. This implies that access, occupancy and working conditions are controlled for radiation protection purposes. In facilities that use x rays for medical

imaging, these areas are usually in the immediate areas where x-ray equipment is used, such as x-ray procedure rooms and x-ray control booths or other areas that require control of access, occupancy and working conditions for radiation protection purposes. The workers in these areas are primarily radiologists and radiographers who are specifically trained in the use of ionizing radiation and whose radiation exposure is usually individually monitored.

Uncontrolled areas² for radiation protection purposes are all other areas in the hospital or clinic and the surrounding environs. Note that trained radiology personnel and other employees, as well as members of the general public, frequent many areas near controlled areas such as film-reading rooms or rest rooms. These areas are treated as uncontrolled in this Report.

1.4 Shielding Design Goals for Medical X-Ray Imaging Facilities and Effective Dose

In this Report, *shielding design goals* (P) are levels of air kerma used in the design calculations and evaluation of barriers constructed for the protection of employees and members of the public. There are different shielding design goals for controlled and uncontrolled areas. The approach for structural shielding design for medical x-ray imaging facilities and the relationship between shielding design goals and the NCRP recommended effective dose limits for radiation workers and members of the public (NCRP, 1993), as they apply to controlled and uncontrolled areas in the design of new facilities, is discussed below. The relationship of E to incident K is complex, and depends on the attenuation of the x rays in the body in penetrating to the radiosensitive organs and hence on the x-ray energy spectrum, and also on the posture of the exposed individual with respect to the source. Rotational exposure *should* be assumed, since it is probable that an individual is moving about and would not be exposed from one direction only. It is not practical to base shielding design directly on E , since E cannot be measured directly. Therefore, for the purposes of this Report, the shielding design goals are stated in terms of K (in milligray) at the point of nearest occupancy beyond the barrier. For example, as discussed in Section 4, the distance of closest approach to an x-ray room wall can be assumed conservatively (on the safe side) to be not <0.3 m.

Shielding design goals (P) are practical values, for a single medical x-ray imaging source or set of sources, that are evaluated

²“Uncontrolled area” has the same meaning as “noncontrolled area” in previous NCRP reports.

at a reference point beyond a protective barrier. When used in conjunction with the conservatively safe assumptions recommended in this Report, the shielding design goals will ensure that the respective annual values for E recommended in this Report for controlled and uncontrolled areas are not exceeded. Shielding design goals are expressed as weekly values since the workload for a medical x-ray imaging source (see Glossary) has traditionally utilized a weekly format.

1.4.1 *Controlled Areas*

The employees who work in controlled areas (*i.e.*, radiation workers) have significant potential for exposure to radiation in the course of their assignments or are directly responsible for or involved with the use and control of radiation. They generally have training in radiation management and are subject to routine personal monitoring.

NCRP recommends an annual limit for E for these individuals of 50 mSv y^{-1} with the cumulative E not to exceed the product of 10 mSv and the radiation worker's age in years (exclusive of medical and natural background radiation) (NCRP, 1993). That notwithstanding, NCRP (1993) recommends that for design of new facilities, E *should* be a fraction of the 10 mSv y^{-1} implied by the cumulative effective dose limit. Another consideration is that a pregnant radiation worker *should not* be exposed to levels that result in greater than the monthly equivalent dose (H_T) limit of 0.5 mSv to the worker's embryo or fetus (NCRP, 1993). To achieve both recommendations, this Report recommends a fraction of one-half of that E value, or 5 mSv y^{-1} , and a weekly shielding design goal (P) of 0.1 mGy air kerma (*i.e.*, an annual air-kerma value of 5 mGy) for controlled areas. The P value adopted in this Report would allow pregnant radiation workers continued access to their work areas.

**Recommendation for controlled areas—
Shielding design goal (P) (in air kerma):
0.1 mGy week⁻¹ (5 mGy y⁻¹)**

1.4.2 *Uncontrolled Areas*

Uncontrolled areas are those occupied by individuals such as patients, visitors to the facility, and employees who do not work routinely with or around radiation sources. Areas adjacent to but not part of the x-ray facility are also uncontrolled areas.

Based on ICRP (1991) and NCRP (1993) recommendations for the annual limit of effective dose to a member of the general

public, shielding designs *shall* limit exposure of all individuals in uncontrolled areas to an effective dose that does not exceed 1 mSv y^{-1} . After a review of the application of the guidance in NCRP (1993) to medical radiation facilities, NCRP has concluded that a suitable source control for shielding individuals in uncontrolled areas in or near medical radiation facilities is an effective dose of 1 mSv in any year. This recommendation can be achieved for the medical radiation facilities covered in this Report with a weekly shielding design goal of $0.02 \text{ mGy air kerma}$ (*i.e.*, an annual air-kerma value of 1 mGy) for uncontrolled areas.

**Recommendation for uncontrolled areas—
Shielding design goal (*P*) (in air kerma):
 $0.02 \text{ mGy week}^{-1}$ (1 mGy y^{-1})**

1.4.3 *Shielding Design Assumptions*

A medical x-ray imaging facility that utilizes the *P* values given above would produce *E* values lower than the recommendations for *E* in this Report for controlled and uncontrolled areas. This is the result of the conservatively safe nature of the shielding design methodology recommended in this Report. Several examples of this conservatism, and the relative impact of each, are given below:

- The significant attenuation of the primary beam by the patient is neglected. The patient attenuates the primary beam by a factor of 10 to 100.
- The calculations of recommended barrier thickness always assume perpendicular incidence of the radiation. If not assumed, the effect would vary in magnitude, but would always be a reduction in the transmission through the barrier for x rays that have nonperpendicular incidence.
- The shielding design calculation often ignores the presence of materials (*e.g.*, lead fluoroscopy curtains, personnel wearing lead aprons, ceiling mounted shields, equipment cabinets, etc.) in the path of the radiation other than the specified shielding material. If the additional materials were included, the effects would vary in magnitude, but the net effect would be a reduction in transmission due to the additional materials.
- The leakage radiation from x-ray equipment is assumed to be at the maximum value allowed by the federal standard for the leakage radiation technique factors for the x-ray device (*i.e.*, 0.876 mGy h^{-1} air kerma) (100 mR h^{-1} exposure)

(FDA, 2003a). In clinical practice, leakage radiation is much less than this value,³ since Food and Drug Administration (FDA, 2003a) leakage technique factors are not typically employed for examination of patients. If the maximum value were not assumed, the effect would be a reduction in leakage radiation and its contribution to secondary radiation.

- The field size and phantom used for scattered radiation calculations yield conservatively high values of scattered radiation. If a more likely field size and phantom were used, the contribution to scattered radiation would be reduced by a factor of approximately four.
- The recommended occupancy factors for uncontrolled areas are conservatively high. For example, very few people spend 100 percent of their time in their office. If more likely occupancy factors were used, the effect would vary in magnitude, but would always result in a reduction in the amount of exposure received by an individual located in an uncontrolled area.
- Lead shielding is fabricated in sheets of specific standard thicknesses. If shielding calculations require a value greater than a standard thickness, the next available greater standard thickness will typically be specified. This added thickness provides an increased measure of protection. The effect of using the next greater standard thickness (Section 2.3.1.1, Figure 2.3) in place of the actual barrier thickness would vary in magnitude, but would always result in a significant reduction in transmission through the barrier.
- The minimum distance to the occupied area from a shielded wall is assumed to be 0.3 m. This is typically a conservatively safe estimate for most walls and especially for doors. If a value >0.3 m were assumed, the effect would vary, but radiation levels decrease rapidly with increasing distance.

The conservatively safe factors discussed above will give a significant measure of assurance to the shielding designer that the actual air kerma transmitted through a barrier designed with the methodology given in this Report will be much less than the

³Knox, H.H. (2004). Personal communication (Center for Devices and Radiological Health, Food and Drug Administration, Rockville, Maryland).

applicable shielding design goal. A new facility can be designed using the methodology recommended in this Report without a significant increase in the cost or amount of structural shielding previously required.

1.4.4 Air-Kerma Limits for Radiographic Films

Radiographic film used in medical x-ray imaging is less sensitive to direct radiation exposure today than in the past (Suleiman *et al.*, 1995). Film stored in darkrooms *should not* be exposed to an air kerma >0.1 mGy during the period it is in storage. This storage period is typically on the order of one month or less. In addition, film stored in cassettes with intensifying screens *should* be stored so that the optical density of the base-plus-fog will not be increased by >0.05 . A maximum air kerma of 0.5 μ Gy is recommended for loaded cassettes during the storage period in the darkroom, which is usually on the order of a few days (Suleiman *et al.*, 1995).

1.5 General Concepts

The term “qualified expert” used in this Report is defined as a medical physicist or medical health physicist who is competent to design radiation shielding for medical x-ray imaging facilities. The qualified expert is a person who is certified by the American Board of Radiology, American Board of Medical Physics, American Board of Health Physics, or Canadian College of Physicists in Medicine.

Radiation shielding *shall* be designed by a qualified expert to ensure that the required degree of protection is achieved. The qualified expert *should* be consulted during the early planning stages since the shielding requirements may affect the choice of location of radiation facilities and type of building construction. The qualified expert *should* be provided with all pertinent information regarding the proposed radiation equipment and its use, type of building construction, and occupancy of nearby areas. It may also be necessary to submit the final shielding drawings and specifications to pertinent regulatory agencies for review prior to construction.

The shielding design goals (P values) in this document apply only to new facilities and new construction and will not require retrofitting of existing facilities. This Report is intended for use in planning and designing new facilities and in remodeling existing facilities. Facilities designed before the publication of this Report and meeting the requirements of NCRP Report No. 49 (NCRP, 1976) need not be reevaluated (NCRP, 1993). The

recommendations in this Report apply only to facilities designed after the date of this publication. Because any radiation exposure may have an associated level of risk (NCRP, 1993), it is important that the qualified expert review the completed facility shielding design to ensure that all anticipated exposures also meet the ALARA (as low as reasonably achievable) principle (NCRP, 1990; 1993) (see Glossary).

Since corrections or additions after facilities are completed are expensive, it is important that structural shielding be properly designed and installed in the original construction process. It is also advisable that the planning include consideration of possible future needs for new equipment and changes in practice or use, increased workloads, and changes in the occupancy of adjacent spaces. New equipment, significant changes in the use of equipment, or other changes that may have an impact on radiation protection of the staff or public require an evaluation by a qualified expert. The final drawings and specifications need to be reviewed by the qualified expert and by the pertinent federal, state or local agency if applicable, before construction is begun. Also, the cost of increasing shielding beyond the minimum value often represents only a small increase in cost.

After construction, a performance assessment (*i.e.*, a radiation survey), including measurements in controlled and uncontrolled areas, *shall* be made by a qualified expert to confirm that the shielding provided will achieve the respective shielding design goal (*P*). The performance assessment is an independent check that the assumptions used in the shielding design are conservatively safe. In addition, it is good radiation protection practice to monitor periodically to ensure that the respective recommendations for *E* (Sections 1.4.1 and 1.4.2) are not exceeded during facility operation.

This Report does not attempt to summarize the regulatory or licensing requirements of the various authorities that may have jurisdiction over matters addressed in this Report. Similarly, no recommendations are made on administrative controls that site operators may choose to implement.

While specific recommendations on shielding design methods are given in this Report, alternate methods may prove equally satisfactory in providing radiation protection. The final assessment of the adequacy of the design and construction of protective shielding can only be based on the post-construction survey performed by a qualified expert. If the survey indicates shielding inadequacy, additional shielding or modifications of equipment and procedures *shall* be made.

2. Fundamentals of Shielding for Medical X-Ray Imaging Facilities

2.1 Basic Principles

In medical x-ray imaging applications, the radiation consists of primary and secondary radiation. *Primary radiation*, also called the useful beam, is radiation emitted directly from the x-ray tube that is used for patient imaging. A *primary barrier* is a wall, ceiling, floor or other structure that will intercept radiation emitted directly from the x-ray tube. Its function is to attenuate the useful beam to appropriate shielding design goals.

Secondary radiation consists of x rays scattered from the patient and other objects such as the imaging hardware and leakage radiation from the protective housing of the x-ray tube. A *secondary barrier* is a wall, ceiling, floor or other structure that will intercept and attenuate leakage and scattered radiations to the appropriate shielding design goal. Figure 2.1 illustrates primary, scattered, leakage and transmitted radiation in a typical radiographic room.

Primary and secondary radiation exposure to individuals depends primarily on the following factors:

- the amount of radiation produced by the source
- the *distance* between the exposed person and the source of the radiation
- the amount of *time* that an individual spends in the irradiated area
- the amount of protective *shielding* between the individual and the radiation source

The exposure rate from the source varies approximately as the inverse square of the distance from the source. To assess the distance from the source when a barrier is in place, it is usually assumed that the individual to be protected is at least 0.3 m beyond the walls bounding the source. The exposure time of an individual

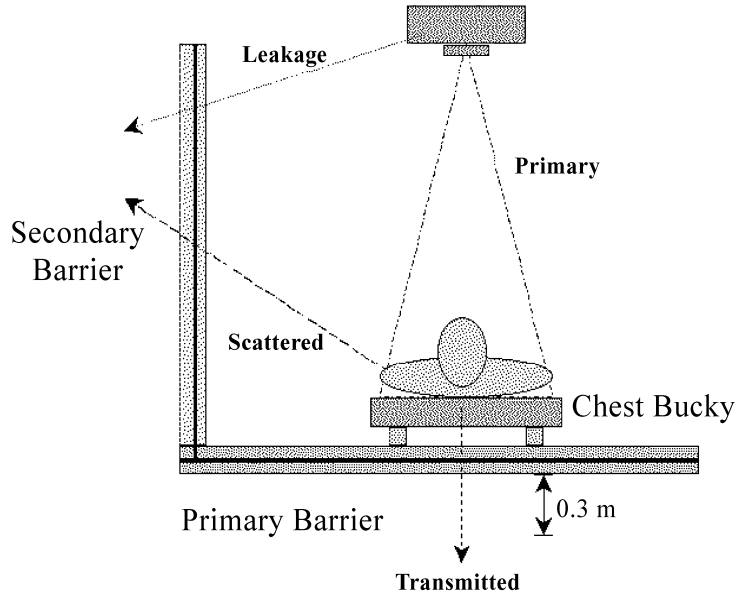

Fig. 2.1. Figure illustrating primary, scattered, leakage and transmitted radiation in a radiographic room with the patient positioned upright against the chest bucky. The minimum distance to the occupied area from a shielded wall is assumed to be 0.3 m.

involves both the time that the radiation beam is on and the fraction of the beam-on time during which a person is in the radiation field. Exposure through a barrier in any given time interval depends on the integrated tube current in that interval [workload in milliamperere-minutes (mA min)], the volume of the scattering source, the leakage of radiation through the x-ray tube housing, and the energy spectrum of the x-ray source. In most applications covered by this Report, protective shielding is required.

2.2 Types of Medical X-Ray Imaging Facilities

2.2.1 Radiographic Installations

A general purpose radiographic system produces brief radiation exposures with applied electrical potentials on the x-ray tube (operating potential) in the range from 50 to 150 kVp (kilovolt peak) that are normally made with the x-ray beam directed down towards the patient, the radiographic table and, ultimately, the floor. However, the x-ray tube can usually be rotated, so that it is possible for the

x-ray beam to be directed to other barriers. Barriers that may be directly irradiated are considered to be primary barriers. Many general purpose radiographic rooms include the capability for chest radiographs where the beam is directed to a vertical cassette assembly, often referred to as a “chest bucky” or “wall bucky.” Additional shielding may be specified for installation directly behind this unit.

Provision *shall* be made for the operator to observe and communicate with the patient on the table or at the vertical cassette assembly. The operator of a radiographic unit *shall* remain in a protected area (control booth) or behind a fixed shield that will intercept the incident radiation. The control booth *should not* be used as a primary barrier. The exposure switch *shall* be positioned such that the radiographer cannot make an exposure with his or her body outside of the shielded area. This is generally accomplished if the x-ray exposure switch is at least 1 m from the edge of the control booth.

The control booth *shall* consist of a permanent structure at least 2.1 m high and *should* contain unobstructed floor space sufficient to allow safe operation of the equipment. The booth *shall* be positioned so that no unattenuated primary or unattenuated single-scattered radiation will reach the operator’s position in the booth. There *shall not* be an unprotected direct line of sight from the patient or x-ray tube to the x-ray machine operator or to loaded film cassettes placed behind a control booth wall.

The control booth *shall* have a window or viewing device that allows the operator to view the patient during all x-ray exposures performed in the room. The operator must be able to view the wall bucky and x-ray table, as well as patients confined to stretchers. When an observation window is used, the window and frame *shall* provide the necessary attenuation required to reduce the air kerma to the shielding design goal. The window(s) *should* be at least 45 × 45 cm and centered 1.5 m above the finished floor. A typical design for a control booth is illustrated in Figure 2.2.

2.2.2 Fluoroscopic Installations

Fluoroscopic imaging systems are usually operated at potentials ranging from 60 to 120 kVp. A primary barrier is incorporated into the fluoroscopic image receptor. Therefore, a protective design for a room containing only a fluoroscopic unit need consider only secondary protective barriers against leakage and scattered radiations. However, the qualified expert may wish to provide fluoroscopic rooms with primary barriers so that the function of the room

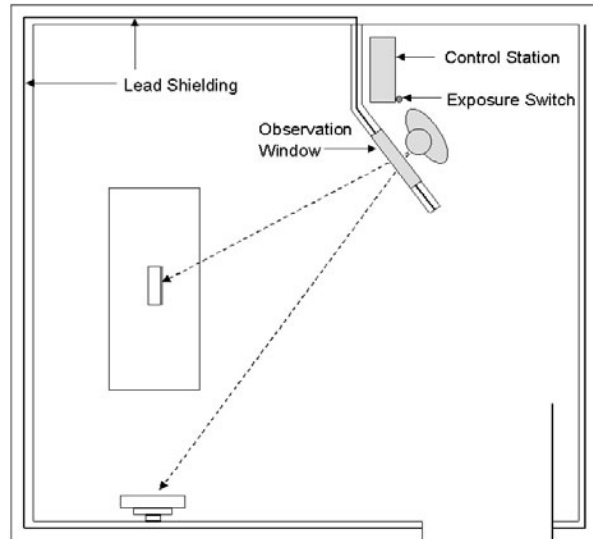

Fig. 2.2. Typical design for a control booth in a radiographic x-ray room surrounded by occupied areas. Dashed lines indicate the required radiographer's line of sight to the x-ray table and wall bucky. The exposure switch is positioned at least 1 m from the edge of the control booth, as discussed in Section 2.2.1.

can be changed at a later date without the need to add additional shielding. Most modern fluoroscopic x-ray imaging systems also include a radiographic tube. The shielding requirements for such a room are based on the combined workload of both units.

2.2.3 *Interventional Facilities*

Interventional facilities include cardiovascular imaging (cardiac catheterization) rooms, as well as peripheral angiography and neuroangiography suites. These facilities, which will be referred to as cardiac angiography and peripheral angiography,⁴ may contain multiple x-ray tubes, each of which needs to be evaluated independently. Barriers *shall* be designed so that the total air kerma from all tubes does not exceed the shielding design goal. The types of studies performed in these facilities often require long fluoroscopy times, as well as cine and digital radiography. Consequently, workloads in interventional imaging rooms generally are high and tube

⁴In this Report, the data for peripheral angiography suites also apply to neuroangiography suites.

orientation may change with each of the studies performed. The shielded control area *should* be large enough to accommodate associated equipment and several persons.

2.2.4 *Dedicated Chest Installations*

In a dedicated chest radiographic room, the x-ray beam is directed to a chest image-receptor assembly on a particular wall. All other walls in the room are secondary barriers. Chest techniques generally require operating potentials >100 kVp. For the wall at which the primary beam is directed, a significant portion that is not directly behind the chest unit may be considered a secondary barrier. However, the segment of the wall directly behind and around the chest bucky is a primary barrier and may require additional shielding. The image receptor may be moved vertically to radiograph patients of various heights and areas of anatomy other than the chest. Therefore, the entire area of the wall that may be irradiated by the primary beam *shall* be shielded as a primary protective barrier.

2.2.5 *Mammographic Installations (Permanent and Mobile)*

Mammography is typically performed at low operating potentials in the range of 25 to 35 kVp. Units manufactured after September 30, 1999 are required to have their primary beams intercepted by the image receptor (FDA, 2003b). Thus permanent mammography installations may not require protection other than that provided by typical gypsum wallboard construction. Furthermore, adequate protective barriers of lead acrylic or lead glass are usually incorporated into dedicated mammographic imaging systems to protect the operator. Although the walls of a mammography facility may not require lead shielding, a qualified expert *shall* be consulted to determine whether the proposed design is satisfactory to meet the recommended shielding design goals. Doors in mammography rooms may need special consideration since wood does not attenuate x rays as efficiently as gypsum wallboard. Designers need to be aware that gypsum wallboard typically contains voids and nonuniform areas. Therefore, one should consider using a greater thickness of gypsum wallboard than required by routine calculations. However, as discussed in Section 5.5, a substantial measure of conservatism (on the safe side) is provided in the mammography energy range by the E to unit air-kerma ratio (ICRP, 1996; ICRU, 1998b).

Mobile or temporary mammographic imaging units present special problems in protection of the patient, staff and members of the public. These *shall* be evaluated by a qualified expert prior to first use.

2.2.6 *Computed Tomography Installations*

Computed tomography (CT) employs a collimated x-ray fan-beam that is intercepted by the patient and by the detector array. Consequently, only secondary radiation is incident on protective barriers. The operating potential, typically in the range of 80 to 140 kVp, as well as the workload are much higher than for general radiography or fluoroscopy. Due to the potential for a large amount of secondary radiation, floors, walls and ceilings need special consideration. Additionally, scattered and leakage radiations from CT systems are not isotropic. Although radiation levels in the direction of the gantry are much less than the radiation levels along the axis of the patient table, the model used in this Report assumes a conservatively safe isotropic scattered-radiation distribution. This is an important consideration if a replacement unit has a different orientation.

2.2.7 *Mobile Radiography and Fluoroscopy X-Ray Units*

Both mobile (or portable) radiographic and fluoroscopic imaging systems are used in the performance of examinations when the condition of the patient is such that transport to a fixed imaging system is not practical. Mobile C-arm fluoroscopic units are often used in cardiac procedures such as pacemaker implantation and in various examinations performed in the operating room, as well as other locations such as pain clinics and orthopedic suites.

Mobile radiographic equipment is used extensively for radiographic examination of the chest and occasionally for abdominal and extremity examinations. These examinations are often performed at bedside in critical care units and in patient rooms. Radiation protection issues involved in the use of mobile radiographic equipment in hospitals and clinic areas are discussed in NCRP Report No. 133, *Radiation Protection for Procedures Performed Outside the Radiology Department* (NCRP, 2000).

If the mobile x-ray equipment is used in a fixed location, or frequently in the same location, a qualified expert *shall* evaluate the need for structural shielding.

2.2.8 *Dental X-Ray Facilities*

Shielding and radiation protection requirements for dental x-ray facilities are covered in NCRP Report No. 145, *Radiation Protection in Dentistry* (NCRP, 2003).

2.2.9 *Bone Mineral Measurement Equipment*

Although bone mineral measurement equipment may not produce images, it does produce ionizing radiation and is a diagnostic modality. Factors similar to those for x-ray equipment need to be evaluated by a qualified expert. This applies to bone mineral measurement equipment in permanent or temporary (mobile) situations. Most modern bone mineral analyzers will not produce scattered radiation levels greater than an air kerma of 1 mGy y^{-1} at 1 m for the workload for a busy facility (2,500 patients per year).⁵ This air-kerma level is equal to the shielding design goal for a fully-occupied uncontrolled area. Therefore, structural shielding is not required in most cases. However, it is recommended that the operator console be placed as far away as practicable to minimize exposures to the operator. See Section 5.7 for a sample calculation of scattered radiation from this type of equipment.

2.2.10 *Veterinary X-Ray Facilities*

Special consideration needs to be given to veterinary x-ray imaging facilities. Although many veterinary subjects are small, large animals are often examined. Shielding and radiation protection requirements *shall* be evaluated by a qualified expert prior to use of the facility. The radiation safety aspects of veterinary radiation facilities will be covered in a forthcoming revision of NCRP Report No. 36, *Radiation Protection in Veterinary Medicine* (NCRP, 1970; in press).

2.2.11 *Other X-Ray Imaging Systems*

New medical x-ray imaging techniques will continue to be developed in the future. All sources of ionizing radiation *shall* be evaluated by a qualified expert in order to determine the type and nature of the shielding required in the facility.

⁵Dixon, R.L. (2003). Personal communication (Wake Forest University, Winston-Salem, North Carolina).

2.3 Shielding Design Elements

2.3.1 Interior Walls

Local building and fire codes, as well as state health-care licensing agencies, specify requirements for wall assemblies that meet Underwriters Laboratories, Inc. standards for life safety. Unshielded walls in contemporary health-care facilities are normally constructed of metal studs and one or more layers of 5/8 inch thick drywall (gypsum wallboard) per side. The corridor side of walls may contain two layers of gypsum wallboard. Several types of shielding materials are available for walls.

2.3.1.1 Sheet Lead. Sheet lead has traditionally been the material of choice for shielding medical imaging x-ray room walls. Figure 2.3 shows the thicknesses of sheet lead (in millimeters and inches) and their nominal weights (in lb foot⁻²) found to be commercially available from a survey of several major suppliers in the United States.⁶ All of these thicknesses may not be available in every area. Figure 2.3 also presents the relative cost per sheet (on average) for each thickness compared to the cost per sheet for the 0.79 mm thickness. Note that the weight in pounds per square foot is equal to the nominal thickness in inches multiplied by 64. For example, 1/16 inch lead is equivalent to 4 lb foot⁻².

For typical shielding applications, a lead sheet is glued to a sheet of gypsum wallboard and installed lead inward with nails or screws on wooden or metal studs. X-ray images of wall segments show that insertion of the nails or screws does not result in significant radiation leaks.⁷ In fact, the steel nails or screws generally attenuate radiation equally, or more effectively, than the lead displaced by the nails. Therefore, steel nails or screws used to secure lead barriers need not be covered with lead discs or supplementary lead. However, where the edges of two lead sheets meet, the continuity of shielding *shall* be ensured at the joints (Section 2.4.2)

2.3.1.2 Gypsum Wallboard. Gypsum wallboard (sheetrock) is commonly used for wall construction in medical facilities. As Glaze *et al.* (1979) pointed out, the gypsum in each sheet is sandwiched

⁶Archer, B.R. (2003). Personal communication (Baylor College of Medicine, Houston, Texas).

⁷Gray, J.E. and Vetter, R.J. (2002). Personal communication (Landauer, Inc., Glenwood, Illinois) and (Mayo Clinic, Rochester, Minnesota), respectively.

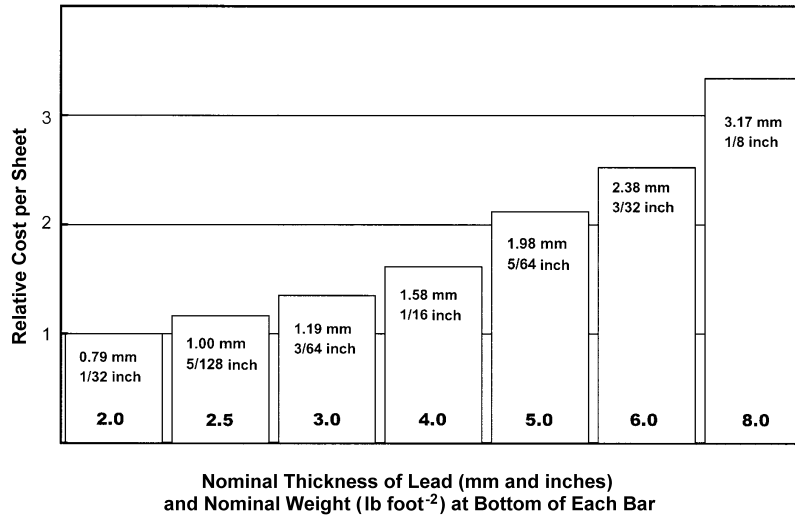

Fig. 2.3. Thicknesses of sheet lead commercially available in a recent survey of several suppliers in the United States. The height of each bar is the relative cost per sheet compared to the 0.79 mm thickness. All the thicknesses given may not be available in every area of the United States.

between a total of 1 mm of paper. A nominal 5/8 inch sheet of “Type X” gypsum wallboard has a minimum gypsum thickness of approximately 14 mm. Although gypsum wallboard provides relatively little attenuation at higher beam energies, it provides significant attenuation of the low-energy x rays used in mammography. As mentioned earlier, gypsum wallboard typically contains voids and nonuniform areas and therefore one *should* be conservatively safe when specifying this material for shielding.

2.3.1.3 Other Materials. Concrete block, clay brick, and tile may also be used to construct interior walls. Generally, manufacturing specifications for these products will be available and the construction standards established for their use will allow the qualified expert, in consultation with the architect, to determine their appropriateness as shielding materials. These materials may contain voids which will require special consideration during shielding design. If there are voids in the blocks or bricks that may compromise the shielding capabilities of the wall, then solid blocks or bricks may be used or the voids may be filled with grout, sand or mortar. The densities of commercial building materials can be found in Avallone and Baumeister (1996).

2.3.2 Exterior Building Walls

Exterior building walls of medical imaging x-ray rooms may be composed of stone, brick, stucco, concrete, wood, vinyl, synthetic stucco, or other material. The range of potential attenuating properties of these materials is very wide and the qualified expert *should* request specific exterior wall design specifications from the architect prior to determining the shielding requirements.

Wall systems are generally determined during the design development phase with the construction details established during the construction document phase. The architect *should* review the plans with the qualified expert during the design development phase of construction for shielding requirements and opportunities for structural modifications.

2.3.3 Doors

2.3.3.1 Lead-Lined Doors. The door and frame must provide at least the attenuation required to reduce the air kerma to the shielding design goal. If lead is required, the inside of the door frame *should* be lined with a single lead sheet and worked into the contour of the frame to provide an effective overlap with the adjoining barrier⁸ (Figure 2.4).

2.3.3.2 Wooden Doors. Wooden doors exhibit limited attenuation efficiency and not all wooden doors are constructed with equal integrity. Some “drop-in-core” models exhibit large gaps between the solid core and outer frame (stiles and rails). Likewise, the “lumber core door” provides very little shielding because the core consists of staggered wooden blocks that are edge glued. This type of core demonstrates numerous voids when radiographed. Another type often classified as a wooden door is a mineral core door. The core of this door consists primarily of calcium silicate, which has attenuation properties similar to gypsum wallboard. However, the stiles and rails are constructed of wood, so the benefit of the additional core attenuation may be reduced.

There are facilities such as mammography installations where design layout, workload factors, and beam energy may allow consideration of solid wood or mineral core wood doors for shielding applications. To ensure the integrity of wooden doors one *should*

⁸Smith, B. (2004). Personal communication (Nelco Lead Company, Woburn, Massachusetts).

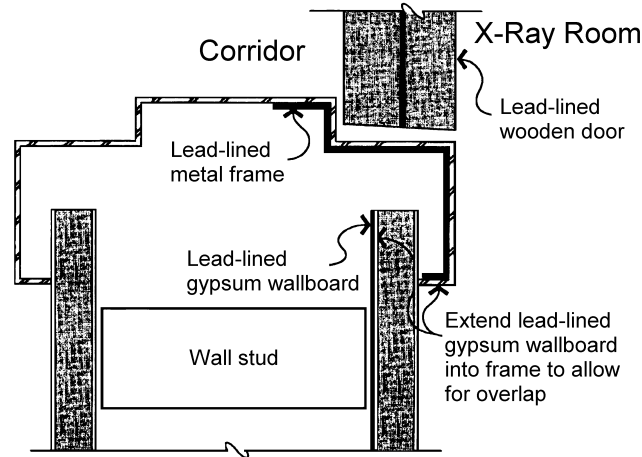

Fig. 2.4. Cross-sectional view of lead-lined door and frame illustrating the proper placement of lead shielding. When the thickness of the metal in the door frame is inadequate, the inside of the frame *should* be lined with a single lead sheet and worked into the contour of the frame to provide an effective overlap with the adjoining barrier.

specify American Woodwork Institute type PC-5 (solid wooden core) or C-45 (mineral core) for shielding applications, or equivalent. American Woodwork Institute standards (AWI, 2003) for these doors state that “the stiles and rails must be securely bonded to the core.”

2.3.3.3 Door Interlocks, Warning Lights, and Warning Signs. Door interlocks that interrupt x-ray production are not desirable since they may disrupt patient procedures and thus result in unnecessary repeat examinations. An exception might be a control room door which represents an essential part of the control barrier protecting the operator. The qualified expert *should* consult local and state regulations with respect to interlocks, warning signs and warning lights.

2.3.4 Windows

There are various types of materials suitable for windows in medical x-ray imaging facilities. It is desirable that the window material be durable and maintain optical transparency over the life of the facility.

2.3.4.1 Lead Glass. Glass with a high lead content can be obtained in a variety of thicknesses. Lead glass is usually specified in terms of millimeter lead equivalence at a particular *kVp*.

2.3.4.2 Plate Glass. Ordinary plate glass may be used only where protection requirements are very low. Typically, two or more 1/4 inch (6.35 mm) thick glass sections are laminated together to form the view window. However, caution must be exercised when specifying thick, large-area plate glass windows because of weight considerations.

2.3.4.3 Lead Acrylic. This product is a lead-impregnated, transparent, acrylic sheet that may be obtained in various lead equivalencies, typically 0.5, 0.8, 1 and 1.5 mm lead equivalence. Lead acrylic is a relatively soft material which may scratch and can become clouded by some cleaning solvents.

2.3.5 Floors and Ceilings

Concrete is a basic construction material used in floor slabs. It may also be used for precast wall panels, walls, and roofs. Concrete is usually designed and specified as standard-weight or light-weight. The radiation attenuation effectiveness of a concrete barrier depends on its thickness, density and composition.

Figure 2.5 illustrates typical floor slab construction used in most health-care facilities, namely metal-deck-supported concrete and slab. The concrete equivalence of the steel decking may be estimated from the attenuation data provided in this Report. The floor slab thickness can vary from as little as 4 cm to >20 cm. For shielding purposes, the minimum concrete slab thickness *should* be incorporated in the shielding design. Optimally, the qualified expert, architect, and structural engineer *should* discuss floor systems and their potential impact on the shielding design as early as possible in the facility design process. A collaborative design could eliminate the need for the costly addition of lead shielding in the floor or ceiling.

2.3.5.1 Standard-Weight Concrete. Standard-weight (or normal-weight) concrete is used for most foundations and main structural elements such as columns, beams and floor slabs. The average density of standard-weight concrete is 2.4 g cm^{-3} (147 lb foot^{-3}). Variations in concrete density may arise from differences in density of the components, from forming or tamping techniques used in the casting or from different proportions used in the mix.

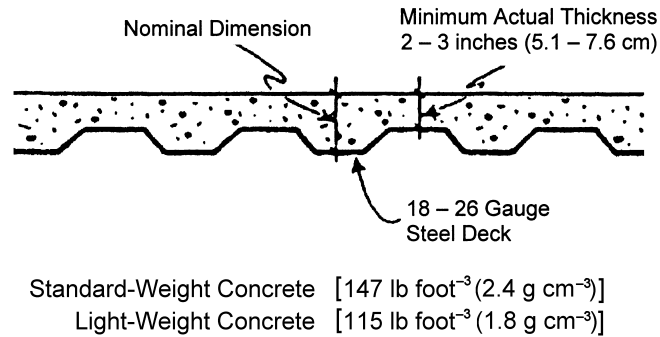

Fig. 2.5. Schematic of a typical concrete floor slab poured on a steel deck. The minimum thickness *should* be used in calculating the barrier thickness.

2.3.5.2 Light-Weight Concrete. Light-weight concrete is often specified in floor slabs as a weight saving and fire protection measure. The air space pores reduce heat conduction, often allowing it to be classified as a primary fire barrier. Typically, light-weight concrete will have a density of 1.8 g cm^{-3} (115 lb foot^{-3}) or about three-quarters that for standard-weight concrete, depending on the aggregate used. “Honeycombing,” the creation of voids in the concrete, will affect its shielding properties. If the total design thickness of concrete is required to meet the shielding design goal, then testing for voids and a plan for corrective measures may be needed.

2.3.5.3 Floor Slab Construction. A typical concrete floor slab is a variable structure as shown in Figure 2.5, having been poured on a steel deck. Note that the minimum thickness of the concrete is less than the nominal dimension which is usually quoted. The minimum thickness *should* be used in calculating the barrier equivalence.

2.3.6 Floor-to-Floor Heights

Floor-to-floor height is the vertical distance from the top of one floor to the top of the next floor. The floor-to-floor height should provide adequate ceiling height for the use and servicing of imaging equipment. Although floor-to-floor height will range from 3 to 5 m, protective shielding need normally extend only to a height of 2.1 m above the floor, unless additional shielding is required in the ceiling directly above the x-ray room (over and above the inherent shielding of the ceiling slab). In this latter case, it may be necessary to

extend the wall lead up to the ceiling shielding material. Darkroom walls may also require shielding that extends to the ceiling to protect film stored on shelves above the standard 2.1 m height.

2.3.7 *Interstitial Space*

Typical interstitial space is 1.5 to 2.4 m in height and contains structural support for maintenance or room for construction personnel to work above the ceiling. The floor of the interstitial space is much thinner than a typical concrete slab, it may be a steel deck without a concrete topping, a steel deck with a gypsum topping, or a steel deck with a light-weight concrete deck. Interstitial space makes it possible for a person to work above or below an x-ray unit while the unit is in operation. The occupancy factor for this space is normally extremely low since access is usually restricted, but this *should* be determined on a case-by-case basis.

2.4 Shielding Design Considerations

2.4.1 *Penetrations in Protective Barriers*

Air conditioning ducts, electrical conduit, plumbing, and other infrastructure will penetrate shielded walls, floors and ceilings. The shielding of the x-ray room *shall* be constructed such that the protection is not impaired by these openings or by service boxes, etc., embedded in barriers. This can be accomplished by backing or baffling these penetrations with supplementary lead shielding. The supplementary thickness *shall* at least have shielding equivalent to the displaced material. The method used to replace the displaced shielding *should* be reviewed by the qualified expert to establish that the shielding of the completed installation will be adequate.

Whenever possible, openings *should* be located in a secondary barrier where the required shielding is less. Other options designed by the qualified expert, such as shielding the other side of the wall that is opposite the penetrated area, may also be effective. Openings in medical x-ray imaging rooms above 2.1 m from the finished floor do not normally require backing since the shielding in these rooms is generally not required above this height.

Field changes in duct and conduit runs are common during construction and corrections made after the room is completed can be expensive. If changes in wall or floor penetrations will impair shielding by the removal of part of it, construction documents *should* note the need to alert the architect, engineer, and qualified expert to ensure the integrity of these barriers.

2.4.2 Joints

The joints between lead sheets *should* be constructed so that their surfaces are in contact and with an overlap of not <1 cm (lead shielding can be purchased with the lead sheet extending beyond the edge of the drywall to allow for adequate overlap). When brick or masonry construction is used as a barrier, the mortar *should* be evaluated, as well as the brick. Joints between different kinds of protective material, such as lead and concrete, *should* be constructed so that the overall protection of the barrier is not impaired. However, small gaps between the lead shielding and the floor will not be detrimental in most cases.

2.5 Construction Standards

Generally, institutional construction is of a high quality and meets the most rigid standards in life safety design. However, construction does not take place in a controlled environment. Site conditions, weather, construction schedules, available materials, and qualifications of construction personnel may ultimately affect the integrity of the completed project. Shielding designs that require excessive precision in order to provide the required shielding may not be obtainable in the field. The qualified expert *should* work closely with the architect and the contractor in areas that require close attention to detail to ensure the appropriate shielding.

2.6 Dimensions and Tolerances

Design and construction professionals often discuss the dimension of system components in “nominal” terms or dimensions. For example, a “two-by-four” piece of wood is actually $1\frac{1}{2} \times 3\frac{1}{2}$ inches (3.8×8.9 cm), a “four-inch” brick is actually $3\frac{5}{8}$ inches thick (9.2 cm), and a nominal 20 cm thick concrete slab may actually be only 15 cm at its thinnest point. Likewise, construction tolerances allow for variations in design dimensions.

The qualified expert *should* request actual material dimensions and material tolerances for the materials and systems used to create the shielding. The qualified expert needs to be aware that some dimensions may be to the center line of a wall, column, beam or slab. The nominal thicknesses, tolerances, and minimum allowed thickness of various shielding materials are shown in Table 2.1.

TABLE 2.1—The nominal thicknesses and tolerances of various shielding materials used in walls, doors and windows (adapted from Archer et al., 1994).

Material	Traditional Designation	Nominal Thickness	Thickness Tolerance	Material Thickness
Sheet lead (ASTM, 2003a)	lb foot ⁻²	≤2.54 mm >2.54 mm	-0.13 mm, +0.20 mm ±5% of specified thickness	—
Steel (SDI, 2003)	16 gauge	0.057 inch	-0.004 inch	1.4 mm ^a
	18 gauge	0.045 inch	-0.003 inch	1.1 mm ^a
	20 gauge	0.034 inch	-0.002 inch	0.86 mm ^a
Plate glass (ASTM, 2001)	1/4 inch	0.23 inch (0.58 cm)	0.22 to 0.24 inch (0.56 to 0.62 cm)	5.6 mm ^b
Gypsum wallboard (ASTM, 2003b)	5/8 inch	5/8 inch (1.59 cm)	±1/64 inch (±0.04 cm)	14 mm ^c
Wooden doors (AWI, 2003)	1 3/4 inch	1 3/4 inch (4.45 cm)	±1/16 inch (±0.16 cm)	43 mm ^d

^aThis value represents the thickness of a single sheet of steel of the indicated gauge. For shielding applications, two sheets of steel of a given gauge are used in steel doors (e.g., for 16 gauge, the steel thickness in the door would be 2.8 mm).

^bThis value represents a "single pane" of 1/4 inch plate glass.

^cThis value represents the gypsum thickness in a single sheet of 5/8 inch "Type X" gypsum wallboard.

^dThis value represents the thickness of a single, solid-core wooden door.

3. Elements of Shielding Design

3.1 Strategic Shielding Planning

Strategic shielding planning for a medical x-ray imaging department incorporates a knowledge of basic planning, the ALARA principle, and shielding principles. The strategic planning concept involves the use of shielding options dictated by a knowledge of the sources of radiation in a facility, the occupancy and usage of adjacent areas, and whether specific walls, floors and ceilings are primary or secondary barriers.

The qualified expert and architect need to be aware, for example, that the use of exterior walls and adjacent spaces, both horizontal and vertical, can often be cost-effective elements in the design of radiation shielding. As shown in Figure 3.1, a corridor can be used to separate offices and support rooms from the x-ray examination rooms rather than leaving these rooms adjacent to one another. This strategy will often reduce the amount of shielding required to meet the shielding design goal. The corridor is a low occupancy area and the occupied spaces (offices and lounges) are at least 2.5 m further from the source of x rays. The same strategy applies for spaces above and below (*i.e.*, locating an x-ray room above or below a corridor or mechanical room rather than an occupied office is an effective strategy for reducing shielding requirements). Certain wall and door materials required for building and life safety codes may provide cost-effective alternatives to lead shielding.

The effective and efficient use of shielding materials and the development of optimal design strategies require communication and cooperation among the architect, facility representative, and qualified expert (Roeck, 1994).

3.2 Project Development Process

The project development process will vary from institution to institution. In addition, small projects may be developed differently from large projects. However, a project development process will most likely consist of the five phases discussed in Sections 3.2.1 through 3.2.5.

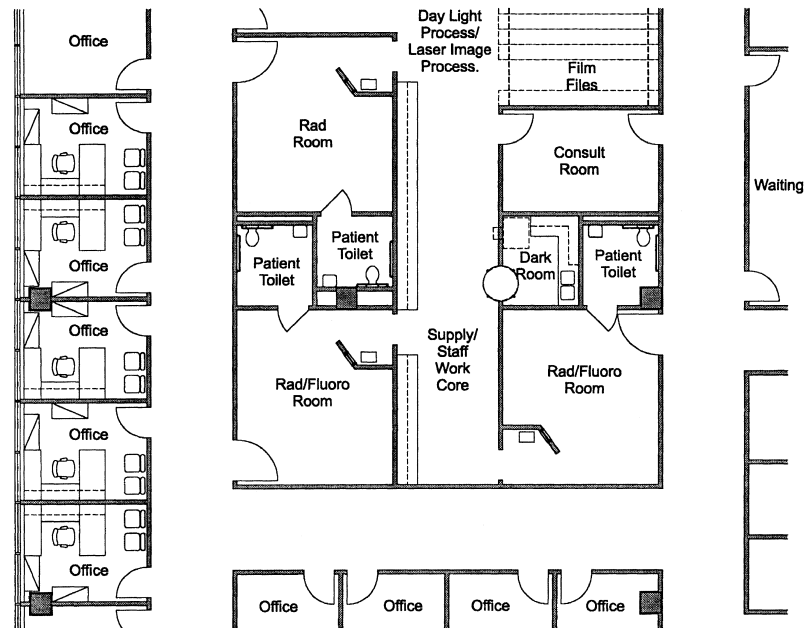

Fig. 3.1. Placing the corridor, as shown above, separating offices and support rooms from the x-ray examination rooms rather than having the rooms immediately adjacent will often reduce the amount of shielding required to meet the shielding design goal. The corridor is a low occupancy space and the occupied space (offices and lounges) are at least 2.5 m further from the source of x rays.

3.2.1 Strategic Planning and Budgeting

Almost every institution or business goes through an annual budgeting process. In addition, most institutions will undertake major strategic planning sessions every few years. During the budgeting process or strategic planning process, decisions will be made to enter into new or existing businesses or services, or to purchase new capital equipment. When these processes involve new construction or purchase of new radiological equipment, the qualified expert *should* be consulted to help develop comprehensive budgets and schedules. While the cost of shielding is a relatively modest component of any project cost, the goal is to be as accurate as possible in the initial decision-making process and to apply the ALARA principle when considering monetary cost-benefit optimization.

3.2.2 *Programming*

The purpose of the programming phase is to prepare a detailed comprehensive list of rooms, their sizes and any special requirements of each room. During this phase the qualified expert can provide information concerning shielding requirements and suggest floor plans that will help minimize shielding requirements. Cooperation between the qualified expert and the space programmer at this phase will help create a safe, efficient health-care environment.

3.2.3 *Schematic (Preliminary) Design*

During the schematic or preliminary design phase the architect begins to organize the rooms into a workable efficient plan to illustrate the scope of the project. Single-line floor plans to scale, notes, and outline specifications of major materials and systems are produced. The qualified expert *should* be involved in the schematic design phase. The qualified expert can help determine appropriate floor plans and point out walls, floors and ceilings that will need to be studied for potential shielding requirements. The architect and qualified expert can begin to consider appropriate materials and systems that will meet project goals and contribute to the shielding design.

3.2.4 *Design Development*

This is the design refinement phase. Rooms, sizes and locations will be determined in much greater detail and the design will be finalized. The architect and mechanical, electrical, plumbing and structural engineers will begin to fix the scope of work. Structural systems and major duct sizing and location will be determined. The qualified expert *should* be provided with the equipment layout for each room in order to determine which walls, floors or ceiling are primary barriers and to evaluate problems of line-of-sight scattered radiation from the x-ray table or chest bucky to the operator or to the occupied areas beyond the control barrier outside the room. At this point, the qualified expert may work with the architect and structural engineer to become aware of the actual structural systems to be used and the design thickness of floor and ceiling slabs. In renovation projects, architects and engineers will investigate existing conditions including types of structural systems, and floor and roof slab thickness. It is important for the qualified expert and architect to determine the occupancy of the spaces

above and below the x-ray source. In small projects, this phase may be eliminated and the activities shifted to the early steps of the construction document phase.

3.2.5 Construction Document Preparation

Construction and contract documents, work drawings, and blueprints are almost interchangeable terms used to identify the drawings and specifications prepared during this phase. At this point, details of the project are finalized. Dimensions, floor plans, wall sections, wall elevations, system details, materials, and construction directions are documented. This set of documents illustrates the detail drawings such as door and window frames, wall penetrations, and any of the shielding details required to meet the qualified expert's requirements. The location and size of vertical duct chases are shown on the drawings and the shielding specifications are detailed in the wall and floor sections. The qualified expert should review the construction documents with the architect prior to the release of the documents for bidding. The qualified expert *shall* specify where shielding is needed and the amount of shielding required prior to construction. In addition, the qualified expert *shall* review any final changes which may modify shielding requirements. If required, the final shielding drawings and specifications are submitted to the pertinent local, state and federal agencies before construction is begun.

3.3 Documentation Requirements

The following documentation shall be maintained on a permanent basis by the operator of the facility:

- shielding design data including assumptions and specifications
- construction, or as-built, documents showing location and amounts of shielding material installed
- post-construction survey reports
- information regarding remedies, if any were required
- more recent reevaluations of the room shielding relative to changes (in utilization, etc.) that have been made or are still under consideration

A permanent placard *should* be mounted by the contractor in the room specifying the amount and type of shielding in each of the walls.

4. Computation of Medical X-Ray Imaging Shielding Requirements

4.1 Concepts and Terminology

4.1.1 *Shielding Design Goals*

Shielding design goals are used in the design or evaluation of barriers constructed for the protection of employees and members of the public. The weekly shielding design goal for a controlled area is an air-kerma value of $0.1 \text{ mGy week}^{-1}$. The weekly shielding design goal for an uncontrolled area is an air-kerma value of $0.02 \text{ mGy week}^{-1}$. Discussion of these values as the basis for shielding design goals was presented in Section 1.4.

4.1.2 *Distance to the Occupied Area*

The distance (d) to the occupied area of interest *should* be taken from the source to the nearest likely approach of the sensitive organs of a person to the barrier. For a wall this may be assumed to be not $<0.3 \text{ m}$. For a source located above potentially occupied spaces, the sensitive organs of the person below can be assumed to be not $>1.7 \text{ m}$ above the lower floor, while for ceiling transmission the distance of at least 0.5 m above the floor of the room above is generally reasonable. In some special cases, such as a nursing station or outdoor sidewalk, the distance from the barrier to the nearest routinely occupied area may be considerably greater.

4.1.3 *Occupancy Factors*

The occupancy factor (T) for an area is defined as the average fraction of time that the maximally exposed individual is present while the x-ray beam is on. Assuming that an x-ray unit is randomly used during the week, the occupancy factor is the fraction of the working hours in the week that a given person would occupy the area, averaged over the year. For example, an outdoor area adjacent to an x-ray room having an assigned occupancy factor of $1/40$ would imply that a given member of the public would spend an

average of 1 h week⁻¹ in that area (while the x-ray beam is activated) every week for a year. A factor of 1/40 would certainly be conservatively safe for most outdoor areas used only for pedestrian or vehicular traffic (*e.g.*, sidewalks, streets, vehicular drop-off areas, or lawn areas with no benches or seating). The occupancy factor for an area is not the fraction of the time that it is occupied by any persons, but rather is the fraction of the time it is occupied by the *single* person who spends the most time there. Thus, an unattended waiting room might be occupied at all times during the day, but have a very low occupancy factor since no single person is likely to spend >50 h y⁻¹ in a given waiting room. Occupancy factors in uncontrolled areas will rarely be determined by visitors to the facility or its environs who might be there only for a small fraction of a year. The maximally exposed individuals will normally be employees of the facility itself or residents or employees of an adjacent facility. For example, if a staff member typically spent 4 h d⁻¹ in a room a physician uses for patient examinations, the resulting occupancy factor would be one-half.

In some cases, a clinic may plan to operate radiographic equipment longer than a normal work day. Two common examples are a radiographic room in an emergency department and a CT facility. The workload utilized should be that which occurs during the primary work shift, since the maximally exposed individuals are those working during that shift. For example, the primary 40 h work shift may occur from 8 a.m. to 5 p.m., 5 d week⁻¹.

Note that the use of T less than one allows the average air kerma in a partially occupied area to be higher than that for a fully-occupied area by a factor of T^{-1} .

The qualified expert should make reasonable and realistic assumptions concerning occupancy factors, since each facility will have its own particular circumstances. For example, an outdoor area that has benches where employees can eat lunch will have an occupancy factor influenced by the climate of the locale. It must be stressed that the occupancy factors in Table 4.1 are general guidance values that may be utilized if more detailed information on occupancy is not available. The designer of a new facility *should*, however, keep in mind that the function of adjacent areas may change over time. For example, a storage room may be converted into an office without anyone reconsidering the adequacy of the existing shielding, particularly if the conversion is made in an adjacent uncontrolled area.

Care must also be taken when assigning a low occupancy factor to an uncontrolled area such as a corridor immediately adjacent to an x-ray room. The actual limitation for shielding design may be a

TABLE 4.1—*Suggested occupancy factors^a (for use as a guide in planning shielding where other occupancy data are not available).*

Location	Occupancy Factor (<i>T</i>)
Administrative or clerical offices; laboratories, pharmacies and other work areas fully occupied by an individual; receptionist areas, attended waiting rooms, children's indoor play areas, adjacent x-ray rooms, film reading areas, nurse's stations, x-ray control rooms	1
Rooms used for patient examinations and treatments	1/2
Corridors, patient rooms, employee lounges, staff rest rooms	1/5
Corridor doors ^b	1/8
Public toilets, unattended vending areas, storage rooms, outdoor areas with seating, unattended waiting rooms, patient holding areas	1/20
Outdoor areas with only transient pedestrian or vehicular traffic, unattended parking lots, vehicular drop off areas (unattended), attics, stairways, unattended elevators, janitor's closets	1/40

^aWhen using a low occupancy factor for a room immediately adjacent to an x-ray room, care *should* be taken to also consider the areas further removed from the x-ray room. These areas may have significantly higher occupancy factors than the adjacent room and may therefore be more important in shielding design despite the larger distances involved.

^bThe occupancy factor for the area just outside a corridor door can often be reasonably assumed to be lower than the occupancy factor for the corridor.

more distant, fully occupied area, such as an office across the corridor. The qualified expert needs to therefore take a larger view of the facility in arriving at the appropriate limitations for shielding design.

Radiation workers may be assumed to spend their entire work period in controlled areas. Therefore, controlled areas such as x-ray rooms and control booths *should* be designed with an occupancy factor of unity. Areas within the department or suite which are not directly related to the use of radiation should not be classified as controlled areas.

The interior spaces of unrelated offices or buildings adjacent to the x-ray facility that are not under the control of the administrator

of the x-ray facility *should* normally be considered as fully occupied ($T = 1$), regardless of the nature of the adjacent interior area, since these areas are subject to change in function without the knowledge or control of the x-ray facility. This is also applicable to adjacent space for which future occupancy is anticipated. This does not apply to the grounds of an adjacent building where fractional occupancy factors may be utilized.

4.1.4 Workload and Workload Distribution

The workload (W) of a medical imaging x-ray tube is the time integral of the x-ray tube current over a specified period and is conventionally given in units of milliamperere-minutes. The most common period of time in which the workload is specified is one week. However, it is also useful to define the normalized workload (W_{norm}) as the average workload per patient. Note that W_{norm} may include multiple exposures depending on the type of radiographic examination and clinical goal. The product of W_{norm} and the average number of patients per week (N) is the total workload per week (W_{tot}):

$$W_{\text{tot}} = N W_{\text{norm}}. \quad (4.1)$$

It is important to distinguish between the number of patients examined in a week (N) as used in this Report [on which is based the average workload per patient (W_{norm}) from the AAPM survey (Simpkin, 1996a)] and the number of “examinations” performed in a given x-ray room. An “examination” refers to a specific x-ray procedure (as defined by a uniform billing or current procedural terminology code). A single patient may receive several such “examinations” while in the x-ray room and that may even involve more than one image receptor (*e.g.*, both the image receptor associated with the x-ray table and the one associated with the chest bucky). Although this may produce a notable patient-to-patient workload variance, the average workload per patient for each room type is likely to be close to the W_{norm} values of the AAPM survey. The designer should be aware that workload information provided by facility administrators stated in terms of a weekly number of “examinations” or “patient examinations” is not the proper value to use for N (and may be several times larger than N). Values of N that may be used for various types of x-ray rooms as a guide, if the actual value of N is not available, are provided later in this Section.

For a radiographic room, some patients are examined using both the x-ray table and chest bucky, and the average workload per

patient has been divided into two components. These components represent the division of the total workload per patient (as well as its kVp distribution) between the x-ray table and the chest bucky for the “average patient” in the survey. It is therefore unnecessary to separately specify the number of patients undergoing chest examinations. Rather the same value of N *should* be used for both the chest bucky and x-ray table calculations, since the fraction of patients who receive examinations on the x-ray table or at the chest bucky is already accounted for by the value of the workload per patient for each image receptor. This methodology also renders unnecessary the incorporation of a fractional use factor for the primary beam against the chest bucky (*i.e.*, $U = 1$) when using the *Rad Room (chest bucky)* workload distribution with the same value of N as is used for all of the calculations for that room. These concepts are demonstrated in Sections 5.3 and 5.4.

At a given x-ray tube operating potential and a given distance, the air kerma at a given reference point from the primary beam is directly proportional to the workload.

Traditional shielding methods have assumed that a conservatively high total workload per week is performed at a single high operating potential, for example, 1,000 mA min week⁻¹ at 100 kVp. This assumption ignores the fact that the medical imaging workload is spread over a wide range of operating potentials. For example, in a general purpose radiographic room, extremity examinations (typically about one-third of the total examinations done in the room) are normally performed at about 50 to 60 kVp, abdominal examinations at about 70 to 80 kVp, and chest examinations at >100 kVp, but with a very low tube current-time (milliampereminutes) product.

For shielding design, the distribution of workload as a function of kVp is much more important than the magnitude of the workload since the attenuation properties of barriers exhibit a strong kVp dependence. For example, the radiation level on the protected side of a 1 mm lead barrier varies exponentially with kVp (three orders of magnitude over the range of 60 to 100 kVp), whereas it varies only linearly with the workload. Leakage radiation from the x-ray tube housing shows an even more dramatic change with kVp , decreasing by more than eight orders of magnitude over the range from 150 to 50 kVp.

Simpkin (1996a) published the results of a nationwide survey measuring the kVp distribution of workload and use factors using data provided by the American Association of Physicists in Medicine (AAPM) Diagnostic X-Ray Imaging Committee Task Group

No. 9 (AAPM TG9). Workload distributions were determined at 14 medical institutions involving approximately 2,500 patients and seven types of radiology installations. Values for the kVp distribution of workload in 5 kVp intervals for each type of installation are reported in Table 4.2. These distributions form the basis of a theoretical model that will be used in this Report. Figure 4.1 compares the workload distribution from the survey for the primary x-ray beam directed at the floor of a radiographic room [*i.e.*, *Rad Room (floor or other barriers)*] with the single 100 kVp “spike” that results from the assumption that all exposures are made at the same kVp .

The surveyed clinical workload distributions are specific for a given type of radiological installation. They will be referred to as:

- *Rad Room (all barriers)* (used only for secondary barriers)
- *Rad Room (chest bucky)*
- *Rad Room (floor or other barriers)*
- *Fluoroscopy Tube (R&F room)*
- *Rad Tube (R&F room)*
- *Chest Room*
- *Mammography Room*
- *Cardiac Angiography*
- *Peripheral Angiography*⁹

where “Rad Room” indicates a room with radiographic equipment only, and “R&F room” refers to a room that contains both radiographic and fluoroscopic equipment.

The workload distribution designated *Rad Room (all barriers)* was measured by the AAPM-TG9 survey (Simpkin, 1996a) for all exposures made in standard radiography rooms which contained a chest bucky and radiographic table but no fluoroscopy capability. This may be broken into the workload directed solely toward the chest bucky and that directed toward all other barriers in the room. There is a significant difference between these two distributions; imaging is performed with the chest bucky typically using higher operating potentials (often >100 kVp) compared with radiation fields directed toward other barriers in the room. Note that the bulk of the *Rad Room (floor or other barriers)* workload distribution is significantly below 100 kVp. The *Rad Room (all barriers)* workload distribution describes all radiation exposures produced in the radiographic room. It is composed of the sum of *Rad Room (chest*

⁹In this Report, the workload distributions for *Peripheral Angiography* also apply to *Neuroangiography*.

TABLE 4.2—Operating potential (kVp) distribution of workload (mA min) normalized per patient, from survey conducted by AAPM TG9 (Simpkin, 1996a).

kVp ^a	Radiography Room ^b										Mammo. Room	Cardiac Angiography	Peripheral Angiography ^d	
	Rad Room (all barriers)	Rad Room (chest bucky)	Rad Room (floor or other barriers)	Fluoro. Tube (R&F room) ^c	Rad Tube (R&F room) ^c	Chest Room	0	0	0	0				
25	0	0	0	0	0	0	0	0	0	0	9.25 × 10 ⁻¹	0	0	0
30	0	0	0	0	0	0	0	0	0	0	4.67	0	0	0
35	0	0	0	0	0	0	0	0	0	0	1.10	0	0	0
40	1.38 × 10 ⁻⁴	0	1.38 × 10 ⁻⁴	0	0	0	0	0	0	0	0	0	0	0
45	7.10 × 10 ⁻⁴	0	7.10 × 10 ⁻⁴	0	5.78 × 10 ⁻⁴	0	0	0	0	0	0	0	0	0
50	8.48 × 10 ⁻³	6.78 × 10 ⁻³	1.70 × 10 ⁻³	0	7.65 × 10 ⁻⁴	0	0	0	0	0	0	3.40 × 10 ⁻¹	8.94 × 10 ⁻²	0
55	1.09 × 10 ⁻²	4.56 × 10 ⁻⁴	1.04 × 10 ⁻²	7.02 × 10 ⁻²	7.26 × 10 ⁻⁴	0	0	0	0	0	0	4.20 × 10 ⁻¹	3.98 × 10 ⁻²	0
60	9.81 × 10 ⁻²	8.96 × 10 ⁻³	8.91 × 10 ⁻²	1.13 × 10 ⁻¹	1.52 × 10 ⁻²	0	0	0	0	0	0	1.96	6.99 × 10 ⁻¹	0
65	1.04 × 10 ⁻¹	3.42 × 10 ⁻²	7.00 × 10 ⁻²	1.87 × 10 ⁻¹	2.52 × 10 ⁻²	0	0	0	0	0	0	4.55	1.50 × 10 ¹	0
70	4.58 × 10 ⁻¹	7.25 × 10 ⁻²	3.85 × 10 ⁻¹	1.45 × 10 ⁻¹	8.89 × 10 ⁻²	2.02 × 10 ⁻²	0	0	0	0	0	6.03	1.22 × 10 ¹	0
75	5.01 × 10 ⁻¹	9.53 × 10 ⁻²	4.05 × 10 ⁻¹	1.94 × 10 ⁻¹	2.24 × 10 ⁻¹	2.36 × 10 ⁻³	0	0	0	0	0	8.02	1.53 × 10 ¹	0
80	5.60 × 10 ⁻¹	1.40 × 10 ⁻¹	4.20 × 10 ⁻¹	1.72	4.28 × 10 ⁻¹	0	0	0	0	0	0	2.54 × 10 ¹	1.10 × 10 ¹	0
85	3.15 × 10 ⁻¹	6.62 × 10 ⁻²	2.49 × 10 ⁻¹	2.19	2.18 × 10 ⁻¹	7.83 × 10 ⁻⁴	0	0	0	0	0	4.03 × 10 ¹	4.09	0
90	1.76 × 10 ⁻¹	1.41 × 10 ⁻²	1.62 × 10 ⁻¹	1.46	5.33 × 10 ⁻²	0	0	0	0	0	0	2.10 × 10 ¹	3.43	0
95	2.18 × 10 ⁻²	3.51 × 10 ⁻³	1.82 × 10 ⁻²	1.15	4.89 × 10 ⁻²	0	0	0	0	0	0	1.06 × 10 ¹	6.73 × 10 ⁻¹	0

kVp^a	Radiography Room ^b							Mammo. Room	Chest Room	Cardiac Angiography	Peripheral Angiography ^d
	Rad Room (all barriers)	Rad Room (chest bucky)	Rad Room (floor or other barriers)	Fluoro. Tube (R&F room) ^c	Rad Tube (R&F room) ^c	Chest Room	Mammo. Room				
100	1.55×10^{-2}	8.84×10^{-4}	1.46×10^{-2}	1.12	5.87×10^{-2}	3.01×10^{-2}	0	7.40	1.53		
105	3.48×10^{-3}	1.97×10^{-3}	1.51×10^{-3}	9.64×10^{-1}	1.05×10^{-2}	0	0	7.02	9.27×10^{-2}		
110	1.05×10^{-2}	9.91×10^{-3}	5.51×10^{-4}	7.47×10^{-1}	6.46×10^{-2}	2.14×10^{-2}	0	6.59	3.05×10^{-2}		
115	4.10×10^{-2}	3.74×10^{-2}	3.69×10^{-3}	1.44	2.90×10^{-2}	9.36×10^{-2}	0	1.38×10^1	0		
120	6.99×10^{-2}	5.12×10^{-2}	1.87×10^{-2}	9.37×10^{-1}	1.04×10^{-1}	4.74×10^{-2}	0	3.35	0		
125	4.84×10^{-2}	4.81×10^{-2}	3.47×10^{-4}	1.38×10^{-1}	8.13×10^{-2}	0	0	2.75	0		
130	1.84×10^{-3}	1.71×10^{-3}	1.25×10^{-4}	1.53×10^{-1}	4.46×10^{-2}	0	0	3.1×10^{-2}	0		
135	7.73×10^{-3}	7.73×10^{-3}	0	1.46×10^{-1}	9.47×10^{-3}	0	0	0	0		
140	0	0	0	1.92×10^{-2}	4.26×10^{-3}	0	0	0	0		
Total workload: ^e	2.5	0.60	1.9	13	1.5	0.22	6.7	160	64		
Patients per week: ^f	110 (Radiography Room)			18	23	210	47	19	21		

^aThe kVp refers to the highest operating potential in the 5 kVp-wide bin.

^bThe three columns under Radiography Room tabulate the workload distribution for all barriers in the room, for just the wall holding the chest bucky, and for all other barriers exclusive of the wall with the chest bucky.

^cR&F is a room that contains both radiographic and fluoroscopic equipment.

^dThe data in this Table for *Peripheral Angiography* also apply to *Neuroangiography*.

^eThe total workload per patient (W_{norm}) for the room type (in mA min patient⁻¹).

^fThe number of patients per week is the mean value from the survey (Simpkin, 1996a).

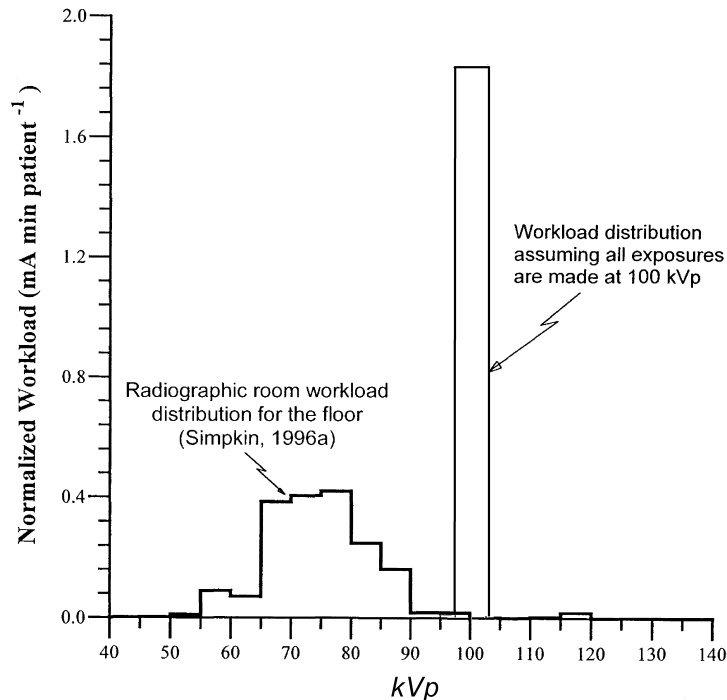

Fig. 4.1. The workload distribution *Rad Room (floor or other barriers)* obtained from the AAPM-TG9 survey (Simpkin, 1996a) for the x-ray beam directed at the floor of a radiographic room compared to the workload distribution assuming all exposures are made at 100 kVp.

bucky) and *Rad Room (floor or other barriers)* distributions. This latter distribution describes exposures directed at the floor, cross-table wall, and any other beam orientations.

Separating the workload into these two barrier-specific distributions provides a more accurate description of the intensity and penetrating ability of the radiation directed at primary barriers. Therefore, it is not necessary to use the *Rad Room (all barriers)* workload distribution for primary beam calculations; it will only be used for secondary barrier shielding calculations.

The actual workload distribution for a given x-ray room will vary from those given in Table 4.2. It will also vary from facility to facility and even from week to week in the same facility. However, the average distribution obtained from the survey represents a more realistic model of x-ray use than the single *kVp* approximation. It also is independent of the number of patients examined

because the workload distributions are scaled per patient. Furthermore, just as a single kVp produces a continuous bremsstrahlung photon spectrum with a corresponding transmission curve for a given shielding material, the workload distribution also produces a continuous spectrum, the attenuation properties of which can also be represented by a single transmission curve. Figure 4.2 shows the primary beam transmission through lead for x rays produced at 100 kVp and also for the *Rad Room (floor or other barriers)* workload distribution shown in Figure 4.1.

The required barrier thickness is that where the transmitted air kerma in the occupied area beyond the barrier does not exceed the weekly shielding design goal scaled by the occupancy factor (*i.e.*, P/T). Using the workload distributions, the unshielded primary or secondary air kerma per patient (or total workload per patient) at 1 m may be calculated. Scaling these by the weekly number of

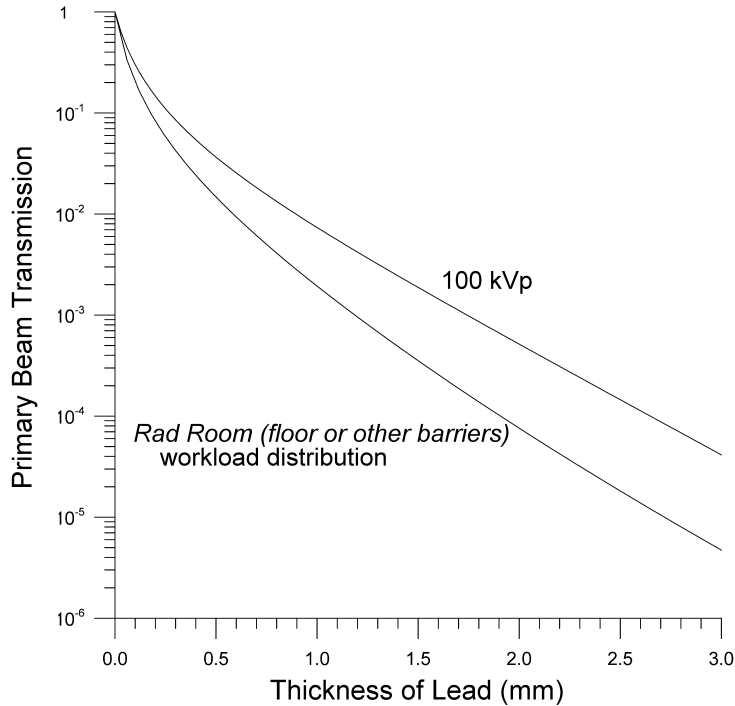

Fig. 4.2. The primary beam transmission through lead for x rays produced at 100 kVp and also for the *Rad Room (floor or other barriers)* workload distribution shown in Figure 4.1.

patients imaged in the x-ray room and correcting by the inverse square of the distance yields the unshielded air kerma in the occupied area. By determining the radiation transmission through a given barrier material for this specific workload distribution, the thickness of the barrier that reduces the unshielded air kerma to the desired value of P/T can be determined. This Section and information contained in the appendices contain the data necessary to perform these calculations.

Table 4.3 lists the typical number of patients for various types of medical x-ray imaging facilities including hospitals and clinics with different patient volume levels. These values may be employed if more accurate information on the number of patients is not available. The qualified expert needs to keep in mind, however, that the per patient values of W_{norm} shown in Table 4.3 could change in the future or they may currently be different for the site being considered. For example, newer modalities such as digital radiography and digital mammography may use techniques that could result in values of W_{norm} different from those listed. In these cases, use of a modifying factor given by $W_{\text{site}}/W_{\text{norm}}$ is required, where W_{site} is the total workload per patient at the installation under consideration. Equation 4.1 may then be modified as follows:

$$W_{\text{tot}} = \frac{W_{\text{site}}}{W_{\text{norm}}} N W_{\text{norm}}. \quad (4.2)$$

The following discussions in this Report will utilize Equation 4.1 and the values in Table 4.3. However, adjustments to W_{norm} shall be made by the qualified expert when appropriate.

4.1.5 Use Factor

The use factor (U) is the fraction of the primary beam workload that is directed toward a given primary barrier. The value of U will depend on the type of radiation installation and the barrier of concern. In radiographic and R&F rooms, the equipment is arranged to allow many different beam orientations, so that different barriers may have different use factors. For example, the workload represented by the *Rad Room (chest bucky)* distribution is directed entirely toward the wall-mounted chest bucky. Therefore $U = 1$ for the area of the wall behind that image receptor and the *Rad Room (chest bucky)* workload distribution contributes only secondary radiation to all other barriers in the room. These other barriers, which include the floor, door(s), and walls (except the wall on which

TABLE 4.3—Estimated total workloads in various medical x-ray imaging installations in clinics and hospitals. The total workload values are for general guidance and are to be used only if the actual workloads are not available.

Room Type	Total Workload per Patient ^a (W_{norm}) (mA min patient ⁻¹)	Typical Number of Patients (N) (per 40 h week)		Total Workload per Week (W_{tot}) (mA min week ⁻¹)	
		Average	Busy	Average	Busy
<i>Rad Room (chest bucky)</i>	0.6	120	160	75	100
<i>Rad Room (floor or other barriers)</i>	1.9	120	160	240	320
<i>Chest Room</i>	0.22	200	400	50	100
<i>Fluoroscopy Tube (R&F room)</i>	13	20	30	260	400
<i>Rad Tube (R&F room)</i>	1.5	25	40	40	60
<i>Mammography Room</i>	6.7	80	160	550	1,075
<i>Cardiac Angiography</i>	160	20	30	3,200	4,800
<i>Peripheral Angiography^b</i>	64	20	30	1,300	2,000

^aAs discussed in Section 4.1.4, values of W_{norm} given in this table can be modified by use of a multiplier term W_{site}/W_{norm} if necessary to account for different workloads per patient at a particular site.

^bThe data in this Table for *Peripheral Angiography* also apply to *Neuroangiography*.

the chest bucky is attached) may serve as primary barriers to some fraction U of the *Rad Room (floor or other barriers)* workload distribution. The primary beam use factors measured by the AAPM-TG9 survey (Simpkin, 1996a) applicable to the *Rad Room (floor or other barriers)* workload distribution are shown in Table 4.4. For convenience, the qualified expert may choose to round these values up to unity for the floor and 0.1 for the cross-table wall. Note that the ceiling and control booth are generally considered secondary barriers in a radiographic room. The AAPM-TG9 survey (Simpkin, 1996a) observed $U = 0$ for those barriers. Since the image-receptor assemblies for mammography and image-intensified fluoroscopy act as a primary beam stop, $U = 0$ for those applications, and only secondary radiation need be considered.

4.1.6 Primary Barriers

A primary barrier is one designed to attenuate the primary beam to the shielding design goal. Primary protective barriers are found in radiographic rooms, dedicated chest installations and radiographic/fluoroscopic rooms. Primary barriers include the portion of the wall on which the vertical cassette holder or “chest-bucky” assembly is mounted, the floor, and those walls toward which the primary beam may occasionally be directed. Figure 4.3 illustrates the relationship of the x-ray source and patient to the primary barrier and shows the primary distance d_p measured from the source to 0.3 m beyond the barrier.

TABLE 4.4—Primary beam use factors (U) for a general radiographic room determined from the survey of clinical sites (Simpkin, 1996a).^a

Barrier	Use Factor (U) ^b	Apply to Workload Distribution
Floor	0.89	<i>Rad Room (floor or other barriers)</i>
Cross-table wall	0.09	<i>Rad Room (floor or other barriers)</i>
Wall No. 3 ^c	0.02	<i>Rad Room (floor or other barriers)</i>
Chest image receptor	1.00	<i>Rad Room (chest bucky)</i>

^aNote that the *Rad Room (all barriers)* workload distribution is not listed in this Table because it is only used for secondary barrier calculations.

^bThe values for U represent the fraction of the workload from the particular distribution that is directed at individual barriers.

^cWall No. 3 is an unspecified wall other than the cross-table wall or the wall holding the upright image receptor (chest bucky).

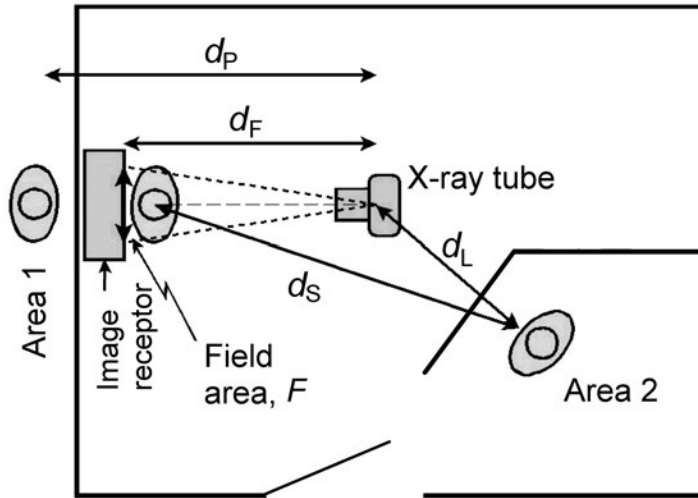

Fig. 4.3. A typical medical imaging x-ray room layout. For the indicated tube orientation, the individual in Area 1 would need to be shielded from the primary beam, with the distance from the x-ray source to the shielded area equal to d_P . The person in Area 2 would need to be shielded from scattered and leakage radiations, with the indicated scattered radiation distance d_S and leakage radiation distance d_L . The primary x-ray beam has area F at distance d_F . It is assumed that individuals in occupied areas reside 0.3 m beyond barrier walls, 1.7 m above the floor below, and 0.5 m above occupied floor levels in rooms above the imaging room. These distances are displayed in Figure 4.4 (Section 4.2.4).

Since the image intensifier in general fluoroscopy, cardiac and peripheral angiography, and the breast support tray in mammography are required by regulation to act as primary beam stops (FDA, 2003c) these rooms do not normally contain primary barriers.

4.1.6.1 Unshielded Primary Air Kerma. Table 4.5 shows the total workload per patient (W_{norm}) as well as the unshielded primary air kerma per patient at 1 m (K_P^1) for each of the workload distributions. The weekly unshielded primary air kerma [$K_P(0)$] in the occupied area due to N patients examined per week in the room is:

$$K_P(0) = \frac{K_P^1 U N}{d_P^2}, \quad (4.3)$$

TABLE 4.5—Unshielded primary air kerma per patient [K_p^1 (in mGy patient⁻¹)] for the indicated workload [W_{norm} (mA min patient⁻¹)] and workload distribution, normalized to primary beam distance $d_p = 1$ m.

Workload Distribution ^a	W_{norm} (mA min patient ⁻¹) ^{b,c}	K_p^1 (mGy patient ⁻¹) ^d
Rad Room (chest bucky)	0.6	2.3
Rad Room (floor or other barriers)	1.9	5.2
Rad Tube (R&F Room)	1.5	5.9
Chest Room	0.22	1.2

^aThe workload distributions are those surveyed by AAPM TG9 (Simpkin, 1996a), given in Table 4.2.

^bAs discussed in Section 4.1.4, values of W_{norm} given in this Table can be modified by use of a multiplier term $W_{\text{site}}/W_{\text{norm}}$ if necessary to allow for different workloads per patient at a particular site.

^cFor the indicated clinical installations, W_{norm} is the average workload per patient.

^dThese values for primary air kerma ignore the attenuation available in the radiographic table and image receptor.

where d_p is the distance (in meters) from the x-ray tube to the occupied area.

4.1.6.2 Preshielding. For primary barrier shielding calculations, it has been traditionally assumed that the unattenuated primary beam is incident on the floor or walls that constitute primary barriers. In fact, the primary beam intensity is substantially reduced due to attenuation by the patient, the image receptor, and the structures supporting the image receptor. The primary beam is not, however, always totally intercepted by the patient since part of it may fall off the patient and impinge directly on the grid or cassette for some projections and patients. The area in which this occurs will, however, be spatially averaged over the primary beam area when the total patient population is considered. Thus, shielding provided by the patient remains a significant factor. Often, a suitably safe approach is to ignore the significant attenuation provided by the patient, and consider only attenuation by the imaging hardware in the x-ray beam. Dixon (1994) and Dixon and Simpkin (1998) have shown that for properly collimated primary beams, the x-ray film cassettes, grids, radiographic tables, and wall-mounted

cassette holders significantly reduce the intensity of primary radiation incident on the barrier. The attenuation provided by this imaging hardware can be expressed as an equivalent thickness of a shielding material. This equivalent thickness of “preshielding” material is designated x_{pre} . Table 4.6 shows the minimum equivalent value of x_{pre} that may be used with any of the workload distributions in Table 4.2 for table or wall-mounted cassette holders, or for the grid and cassette.

If the qualified expert confirms that these image receptors are present in the beam, the net structural barrier required may be determined by subtracting x_{pre} from the computed total primary barrier thickness obtained by assuming that the raw primary beam impinges directly on the barrier.

However, the use of preshielding material *should* be carefully evaluated by the qualified expert to ensure that it is applicable to the barrier under consideration. For table radiography with the beam directed at the floor, the use of preshielding is normally appropriate (Sutton and Williams, 2000). In some cases, however, it may be prudent to ignore the preshielding. For example, in cross-table lateral examinations the beam may not always be fully collimated to the patient and cassette. A chest receptor in some small clinics may consist only of a wall mounted cassette holder which will not contain all of the associated chest-bucky hardware listed in Table 4.6. The examples given in Section 5 show computations of barrier requirements with and without preshielding for completeness. The decision on whether the use of preshielding is

TABLE 4.6—*Equivalent thickness of primary beam preshielding (x_{pre}) (Dixon, 1994).^{a,b}*

Application	x_{pre} (in mm)		
	Lead	Concrete	Steel
Image receptor in radiographic table or wall-mounted cassette holder (attenuation by grid, cassette, and image-receptor supporting structures)	0.85	72	7
Cross-table lateral (attenuation by grid and cassette only)	0.3	30	2

^aSince patient attenuation is ignored, potential variations in image-receptor attenuation from different manufacturers is not a significant factor.

^bCaveats for the use of preshielding are discussed in Section 4.1.6.2.

appropriate rests with the qualified expert. The qualified expert should realize, in any case, that the probability of the primary beam not being intercepted either by the patient or bucky hardware is small.

4.1.7 Secondary Barriers

A secondary barrier is one that limits the air kerma from scattered and leakage radiations generated by the radiographic unit to the appropriate shielding design goal or less. The scattered radiation component is due to photons scattered by the patient and other objects in the path of the primary x-ray beam. The intensity of the scattered radiation increases with the intensity and area of the useful beam. Leakage radiation is that created at the x-ray tube anode and transmitted through the tube housing and the collimator outside of the useful beam area. Manufacturers are currently required by regulation to limit the leakage radiation to 0.876 mGy h⁻¹ air kerma (100 mR h⁻¹ exposure) at 1 m (FDA, 2003a). Compliance with this requirement is evaluated using the maximum operating potential and the maximum beam current at that potential for continuous x-ray tube operation.

Figure 4.3 illustrates the relationship of the x-ray source and patient to the secondary barrier and defines the symbols representing the distances important to secondary barrier calculations.

4.1.7.1 Leakage Radiation. The air kerma from leakage radiation can be estimated by first assuming that the leakage radiation intensity with no housing matches that of the primary beam. At a typical set of leakage radiation technique factors of 150 kVp and 3.3 mA, the x-ray tube housing thickness required to reduce leakage radiation to the regulatory limit given above is equivalent to 2.3 mm of lead. The exposure-weighted workload in each kVp interval of the clinical workload distribution is then attenuated by this equivalent lead thickness and summed to provide the unshielded leakage air kerma per patient at 1 m and is given in Table 4.7. For equipment with maximum operating potentials below 150 kVp, the equivalent x-ray tube housing thickness may be <2.3 mm of lead, but the unshielded secondary air kerma can still be determined using the kVp-specific data available in Simpkin and Dixon (1998). Since the leakage radiation is significantly hardened by the tube housing, penetration through structural shielding barriers is computed using the asymptotic half-value layer (HVL) at high attenuation, or the corresponding attenuation coefficient α , which may be

TABLE 4.7.—Unshielded leakage, scattered and total secondary air kermas (in mGy patient⁻¹) for the indicated workload distributions at $d_S = d_L = 1$ m. The workload distributions and total workloads per patient (W_{norm}) for the indicated clinical sites are the average per patient surveyed by AAPM TG9 (Simpkin, 1996a), listed in Table 4.2. The primary field size F (in cm²) is known at primary distance d_F . Side-scattered radiation is calculated for 90 degree scatter. Forward- and backscattered radiations are calculated for 135 degree scatter.^a Leakage radiation technique factors are 150 kVp at 3.3 mA to achieve 0.876 mGy h⁻¹ (100 mR h⁻¹) for all tubes except mammography, which assumes leakage radiation technique factors of 50 kVp at 5 mA.

Workload Distribution	W_{norm} (mA min patient ⁻¹)	F (cm ²) at d_F (m)	Unshielded Air Kerma (mGy patient ⁻¹) at 1 m				
			Leakage	Side-Scatter	Leakage and Side-Scatter (K_{sec}^1) ^b	Forward/Backscatter	Leakage and Forward/Backscatter (K_{sec}^1) ^c
<i>Rad Room</i> (all barriers)	2.5	1,000	5.3×10^{-4}	3.4×10^{-2}	3.4×10^{-2}	4.8×10^{-2}	4.9×10^{-2}
<i>Rad Room</i> (chest bucky)	0.60	1,535 ^d	3.9×10^{-4}	4.9×10^{-3}	5.3×10^{-3}	6.9×10^{-3}	7.3×10^{-3}
<i>Rad Room (floor or other barriers)</i>	1.9	1,000	1.4×10^{-4}	2.3×10^{-2}	2.3×10^{-2}	3.3×10^{-2}	3.3×10^{-2}
<i>Fluoroscopy Tube</i> (R&F room)	13	730 ^e	1.2×10^{-2}	3.1×10^{-1}	3.2×10^{-1}	4.4×10^{-1}	4.6×10^{-1}
<i>Rad Tube</i> (R&F room)	1.5	1,000	9.4×10^{-4}	2.8×10^{-2}	2.9×10^{-2}	3.9×10^{-2}	4.0×10^{-2}

<i>Chest Room</i>	0.22	1,535 ^d	2.00	3.8×10^{-4}	2.3×10^{-3}	2.7×10^{-3}	3.2×10^{-3}	3.6×10^{-3}
<i>Mammography Room^f</i>	6.7	720 ^g	0.58	1.1×10^{-5}	1.1×10^{-2}	1.1×10^{-2}	4.9×10^{-2}	4.9×10^{-2}
<i>Cardiac Angiography</i>	160	730 ^e	0.90	8.8×10^{-2}	2.6	2.7	3.7	3.8
<i>Peripheral Angiography^h</i>	64	730 ^e	0.90	3.4×10^{-3}	6.6×10^{-1}	6.6×10^{-1}	9.5×10^{-1}	9.5×10^{-1}

^aTo be conservatively safe, the somewhat higher values for backscattered radiation (135 degrees) are used for both backscattered and forward-scattered (30 degrees) radiations (see Figure C.1).

^bThe total secondary air kerma from both leakage and side-scattered radiations.

^cThe total secondary air kerma from both leakage and forward/backscattered radiations.

^dThe area of a 36×43 cm (14 x 17 inches) field.

^eThe area of a 30.5 cm (12 inches) diameter image intensifier.

^fCalculations have shown that 3.6×10^{-2} mGy patient⁻¹ is a conservatively safe maximum value for K_{sec}^1 for all barriers for a standard four-view mammographic examination, when evaluated at 1 m from the isocenter of the mammography unit (Simpkin, 1995) (Section 5.5). The entries in Table 4.7 were evaluated 1 m from the x-ray tube and patient.

^gThe area of a 24×30 cm cassette.

^hThe data in this Table for *Peripheral Angiography* also apply to *Neuroangiography*.

obtained from Table B.1 in Appendix B. That is, the air kerma due to the workload in each kVp interval of the workload distribution is transmitted through the barrier of thickness x_{barrier} with a transmission factor $e^{-\mu x_{\text{barrier}}}$, and summed to get the total transmitted air kerma due to leakage radiation.

4.1.7.2 Scattered Radiation. The magnitude of the air kerma due to scattered radiation is a function of the scattering angle, the number and energy of primary photons incident on the patient, location of the beam on the patient, and the size and shape of the patient. It is assumed that scattered radiation intensity is proportional to the primary beam area at a distance from the focal spot. These parameters are conveniently taken as the image-receptor area and the source-to-image-receptor distance (SID), respectively. The scatter fraction (a_1) is defined as the ratio of the scattered air kerma 1 m from the center of the primary beam area at the patient to the primary air kerma 1 m from the x-ray tube for a given primary beam area. The air kerma for scattered radiation is assumed to scale linearly with primary field area. This reference field size is conveniently taken as the image-receptor area at the SID.

4.1.7.3 Total Contribution from Secondary Radiation. Table 4.7 gives values for unshielded leakage, scattered and total secondary air kermas (the latter being K_{sec}^1) calculated for the clinical workload distributions for the case where the leakage and scattered air kerma distances are both 1 m. The assumed values of the primary beam area (F) at the primary distance (d_p) in meters and the total workload per patient (W_{norm}) used to obtain the values of scattered air kerma (*i.e.*, for side-scattered and forward/backscattered radiations), are also given in Table 4.7.

The air kerma from unshielded secondary radiation [$K_{\text{sec}}(0)$] at a distance d_{sec} for N patients is:

$$K_{\text{sec}}(0) = \frac{K_{\text{sec}}^1 N}{d_{\text{sec}}^2}. \quad (4.4)$$

Strictly speaking, this simplified expression is only correct when d_L and d_s , the distances relevant for leakage and scattered radiation, respectively, are equal. Using the shorter of these two distances for d_{sec} is one acceptable solution. Other acceptable choices are discussed in Sections 5.3 and 5.4 as typical cases are discussed.

4.2 Shielding Calculation Methods

This Section introduces the general equations that will be used to determine barrier requirements and then applies these concepts to primary and secondary barriers.

4.2.1 General Shielding Concepts

The objective of a shielding calculation is to determine the thickness of the barrier that is sufficient to reduce the air kerma in an occupied area to a value $\leq P/T$, the weekly shielding design goal modified by the occupancy factor for the area to be shielded. The broad-beam transmission function $[B(x)]$ is defined as the ratio of the air kerma behind a barrier of thickness x to the air kerma at the same location with no intervening radiation barrier. An acceptable barrier thickness (x_{barrier}) is one in which the value of the broad-beam transmission function¹⁰ is:

$$B(x_{\text{barrier}}) = \left(\frac{P}{T}\right) \frac{d^2}{K^1 N}, \quad (4.5)$$

where d is the distance between the radiation source and the individual beyond the barrier, K^1 is the average unshielded air kerma per patient at 1 m from the source, and N is the expected number of patients examined in the room per week. The transmission characteristics of broad-beam x-ray sources are discussed in Appendix A; transmission curves are provided; and parameters (α , β and γ) are provided for a model that permits an algebraic solution¹⁰ for x_{barrier} as:

$$x_{\text{barrier}} = \frac{1}{\alpha\gamma} \ln \left[\frac{\left(\frac{NTK^1}{Pd^2}\right)^\gamma + \frac{\beta}{\alpha}}{1 + \frac{\beta}{\alpha}} \right]. \quad (4.6)$$

Note that the broad-beam transmission fitting parameters (α , β and γ) depend on the material of the barrier, as well as the workload distribution as a function of kVp .

¹⁰For primary barriers, a use factor (U) is required in Equations 4.5 and 4.6 (see Equations 4.7 and 4.8 in Section 4.2.2).

4.2.2 Shielding for Primary Barriers

The barrier transmission factor (B_p) sufficient to decrease $K_p(0)$ (the air kerma from unshielded primary radiation at a distance d_p) to P/T is given by:

$$B_p(x_{\text{barrier}} + x_{\text{pre}}) = \left(\frac{P}{T}\right) \frac{d_p^2}{K_p^1 UN}. \quad (4.7)$$

Appropriate values for K_p^1 , the unshielded primary air kerma per patient at 1 m, are provided for each of the clinical workload distributions in Table 4.5. The other parameters have already been discussed: P is the weekly shielding design goal in Sections 1.4 and 4.1.1, T is the occupancy factor in Section 4.1.3 with suggested values in Table 4.1, U is the use factor in Section 4.1.5, and d_p is the distance from the source to the location of the maximally exposed individual beyond the primary barrier in Sections 4.1.2 and 4.1.6.

The primary beam transmission functions [$B_p(x_{\text{barrier}})$] for each workload distribution for a variety of shielding materials have been derived and are shown in Appendix B. These were calculated by summing the air kerma in each kVp interval transmitted through a given barrier thickness and dividing that by the total air kerma expected with no barrier. These primary beam transmission curves are shown in Figures B.2 through B.6 for lead, concrete, gypsum wallboard, steel, and plate glass (Appendix B). The structural barrier thickness (x_{barrier}) required to adequately shield against primary radiation may be calculated by determining the total shielding thickness required ($x_{\text{barrier}} + x_{\text{pre}}$), and then if applicable, subtracting the equivalent “preshielding” thickness x_{pre} given in Table 4.6 to obtain x_{barrier} .

Alternatively, an algebraic solution for x_{barrier} , given in Equation 4.8, may be calculated based on the model of Archer *et al.* (1983) for broad-beam transmission (Appendix A):

$$x_{\text{barrier}} = \frac{1}{\alpha\gamma} \ln \left[\frac{\left(\frac{NTUK_p^1}{Pd_p^2} \right)^\gamma + \frac{\beta}{\alpha}}{1 + \frac{\beta}{\alpha}} \right] - x_{\text{pre}}. \quad (4.8)$$

The fitting parameters (α , β and γ) for primary radiation generated by the clinical workload distributions are given in Table B.1 of Appendix B.

4.2.3 Shielding for Secondary Barriers

The barrier transmission factor [$B_{\text{sec}}(x_{\text{barrier}})$] that reduces $K_{\text{sec}}(0)$ (the air kerma from unshielded secondary radiation at a distance d_{sec}) to P/T for secondary radiation is:

$$B_{\text{sec}}(x_{\text{barrier}}) = \left(\frac{P}{T}\right) \frac{d_{\text{sec}}^2}{K_{\text{sec}}^1 N}. \quad (4.9)$$

Appropriate values for K_{sec}^1 , the unshielded secondary air kerma per patient at 1 m, are provided for each of the clinical workload distributions in Table 4.7. The other parameters have already been discussed: P is the weekly shielding design goal in Sections 1.4 and 4.1.1, T is the occupancy factor in Section 4.1.3 with suggested values in Table 4.1, and d_{sec} is the distance from the source of the secondary radiation to the location of the maximally-exposed individual beyond the secondary barrier in Section 4.1.7.3. The thickness x_{barrier} satisfying Equation 4.9 can be graphically determined from Figures C.2 through C.7 in Appendix C.

As before, an algebraic determination of x_{barrier} may also be made. The secondary transmission [$B_{\text{sec}}(x_{\text{barrier}})$] has been fitted to the form of Equations A.2 and A.3 in Appendix A with fitting parameters given in Table C.1 in Appendix C. Substituting $B_{\text{sec}}(x_{\text{barrier}})$ from Equation 4.9 into Equation A.3 yields:

$$x_{\text{barrier}} = \frac{1}{\alpha \gamma} \ln \left[\frac{\left(\frac{NT K_{\text{sec}}^1}{P d_{\text{sec}}^2} \right)^\gamma + \frac{\beta}{\alpha}}{1 + \frac{\beta}{\alpha}} \right]. \quad (4.10)$$

4.2.4 Additional Method for Representative Radiographic Rooms, and Radiographic and Fluoroscopic Rooms

The previously described methods for calculating shielding barrier thicknesses can be readily applied to rooms having an x-ray tube whose orientation is fixed, such as in a dedicated chest unit, or an installation in which only secondary radiation is present, such as for C-arm fluoroscopy. However, the complexity of calculations for installations with multiple x-ray tubes, or variable tube locations and orientations, such as radiographic and R&F rooms, makes these methods more cumbersome. Consider, for example, the cross-table wall in a radiographic room. This barrier has to protect against three radiation sources, namely, the primary radiation

from cross-table exposures, scattered and leakage radiations from over-table projections, and secondary radiation from chest-bucky projections. Because of the variety of distributions of kVp and distance among these radiation sources, this is a surprisingly difficult shielding problem.

To simplify this problem, assumptions may be made regarding the number, orientation and location of x-ray tubes, workload distributions, use factors, and equipment layout typical of clinical installations. Figure 4.4 illustrates elevation (Figure 4.4a) and plan (Figure 4.4b) views of a representative radiographic room or R&F room. Primary x-ray beams are directed toward the radiographic table and the wall-mounted chest bucky, as well as across the table. A shielding barrier in this room needs to reduce the total of both the primary radiation and the sum of transmitted air kerma from all secondary radiation sources to a value no larger than P/T .

While it has traditionally been assumed that the primary radiation would predominate, this may not be true for barriers of low primary workload or use factor. The small size of the model room in Figure 4.4, when viewed as a radiographic room, ensures that the contributions of these various secondary sources are high. The thickness requirements for the various barriers around this room have been calculated using representative workload distributions and use factor information. These barrier thicknesses were calculated assuming the *Rad Room (floor or other barriers) kVp* workload distribution (W_{norm} is $1.9 \text{ mA min patient}^{-1}$) was directed toward an image receptor of $1,000 \text{ cm}^2$ area in the radiographic table (at 100 cm SID), and at a similarly-sized image receptor for the cross-table lateral exposures.

This workload was distributed so that 89 percent was directed down onto the table, two percent directed at the wall opposite the chest bucky, with the remaining nine percent at the cross-table wall. Radiographic exposures following the *Rad Room (chest bucky)* workload distribution (W_{norm} is $0.6 \text{ mA min patient}^{-1}$) were directed at the chest-bucky image receptor (area is $1,535 \text{ cm}^2$ at 1.83 m SID).

From Equations 4.7 and 4.9, it is apparent that the shielding requirements for a given barrier depend on NT/Pd^2 . The required thicknesses of lead and concrete for the various barriers in the radiographic room have been calculated as a function of NT/Pd^2 , as shown in Figures 4.5 and 4.6. For these graphs, P is in milligray per week, N is the number of patients examined each week, and distance d is in meters. The barrier requirements in Figures 4.5 and 4.6 may be applied to a radiographic room by using the value of d appropriate for the barrier of interest in that room. The distance

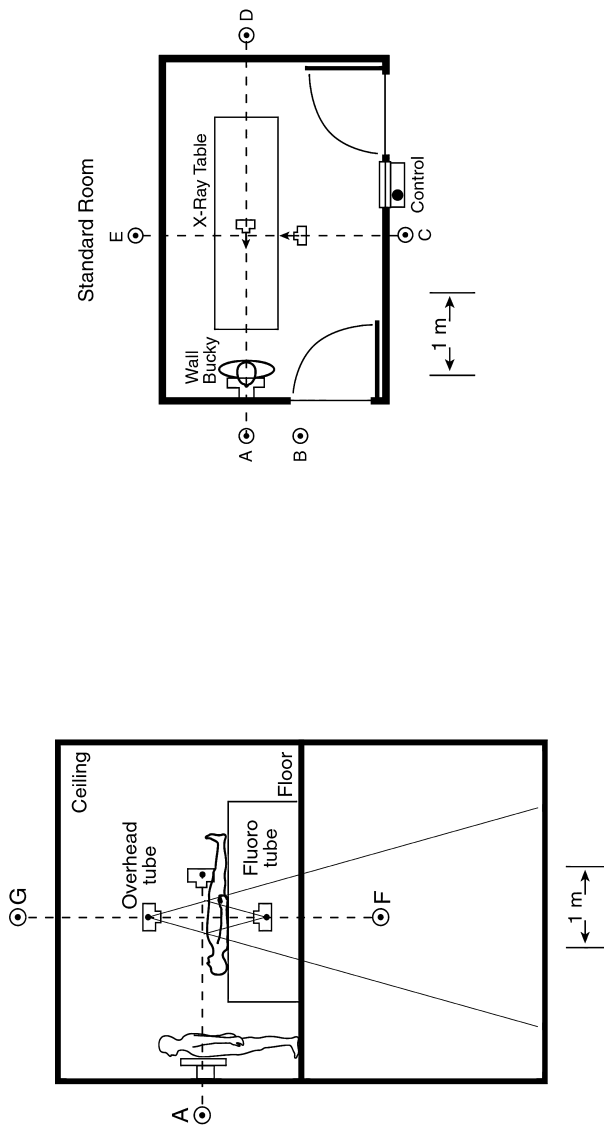

Fig. 4.4. Elevation (left) and plan (right) views of a representative radiographic (or radiographic and fluoroscopic) room. Points A, B, C, D and E represent a distance of 0.3 m from the respective walls. Point F is 1.7 m above the floor below. Point G is taken at 0.5 m above the floor of the room above.

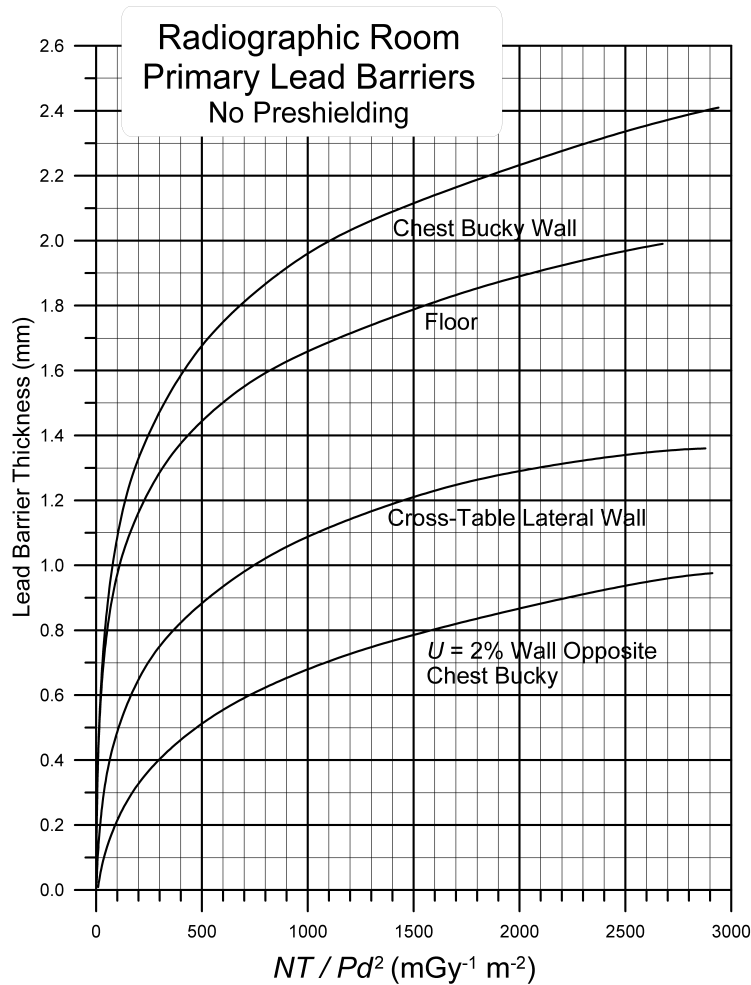

Fig. 4.5a. The lead thickness requirements for primary barriers assuming no preshielding (x_{pre}) in the representative radiographic room as a function of NT/Pd^2 . P is in milligray per week, N is the weekly total number of patients examined in the radiographic room, and d (in meters) is chosen as the distance from the most intense radiation source to the occupied area. If the W_{norm} values given in Table 4.5 do not match the per patient workload for the facility under consideration, then the original value of NT/Pd^2 can be multiplied by W_{site}/W_{norm} , and the modified value can be used to obtain the required shielding from Figure 4.5a.

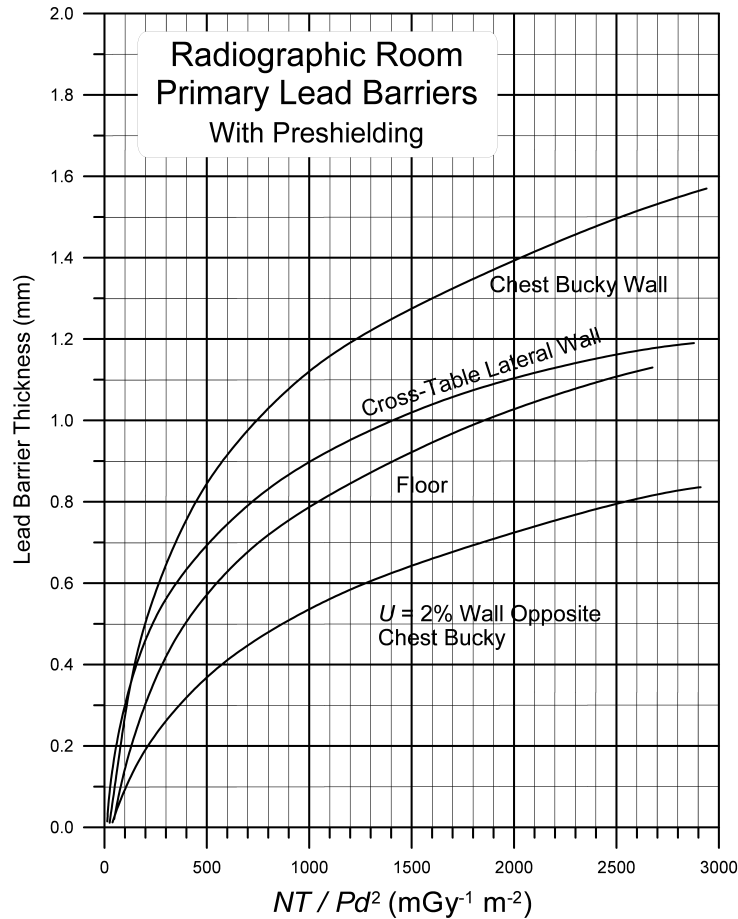

Fig. 4.5b. The lead thickness requirements for primary barriers assuming preshielding (x_{pre}) in the representative radiographic room as a function of NT/Pd^2 (see Section 4.1.6.2 for caveats on x_{pre}). P is in milligray per week, N is the weekly total number of patients examined in the radiographic room, and d (in meters) is chosen as the distance from most intense radiation source to the occupied area. The chest-bucky wall and floor are assumed primary barriers with a cassette, grid, and supporting structures present. The cross-table lateral wall and wall with two percent use factor assume the presence of just a cassette and grid. If the W_{norm} values given in Table 4.5 do not match the per patient workload for the facility under consideration, then the original value of NT/Pd^2 can be multiplied by W_{site}/W_{norm} , and the modified value can be used to obtain the required shielding from Figure 4.5b.

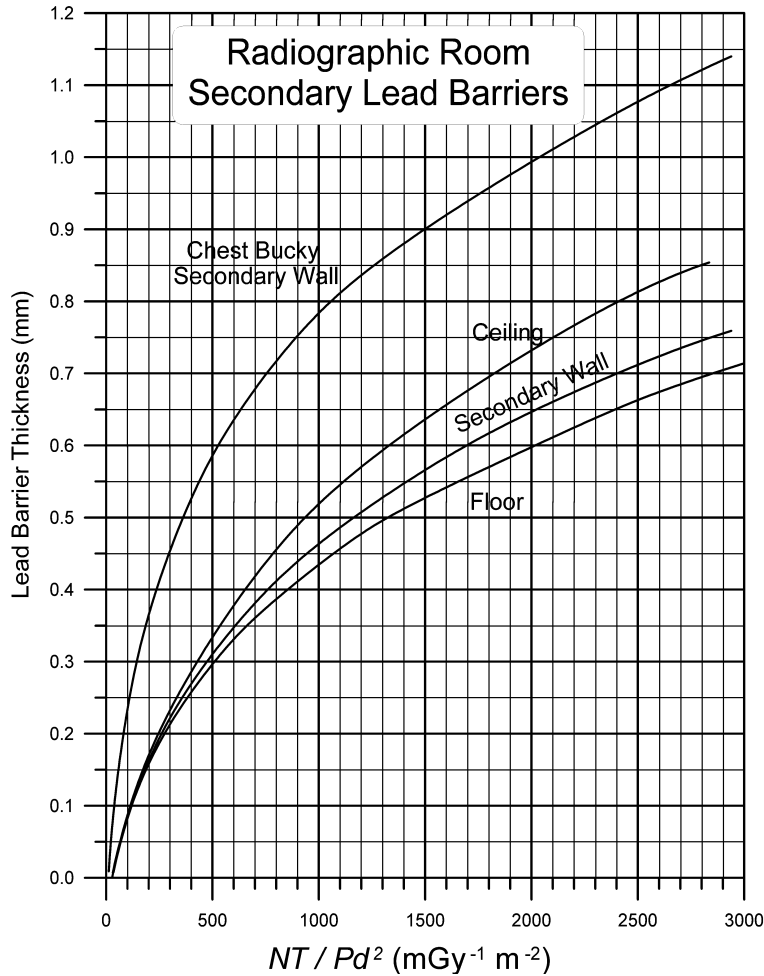

Fig. 4.5c. The lead thickness requirements for secondary barriers in the representative radiographic room as a function of NT/Pd^2 . P is in milligray per week, N is the weekly total number of patients examined in the radiographic room, and d (in meters) is chosen as the distance from the most intense radiation source to the occupied area. If the W_{norm} values given in Table 4.5 do not match the per patient workload for the facility under consideration, then the original value of NT/Pd^2 can be multiplied by W_{site}/W_{norm} , and the modified value can be used to obtain the required shielding from Figure 4.5c.

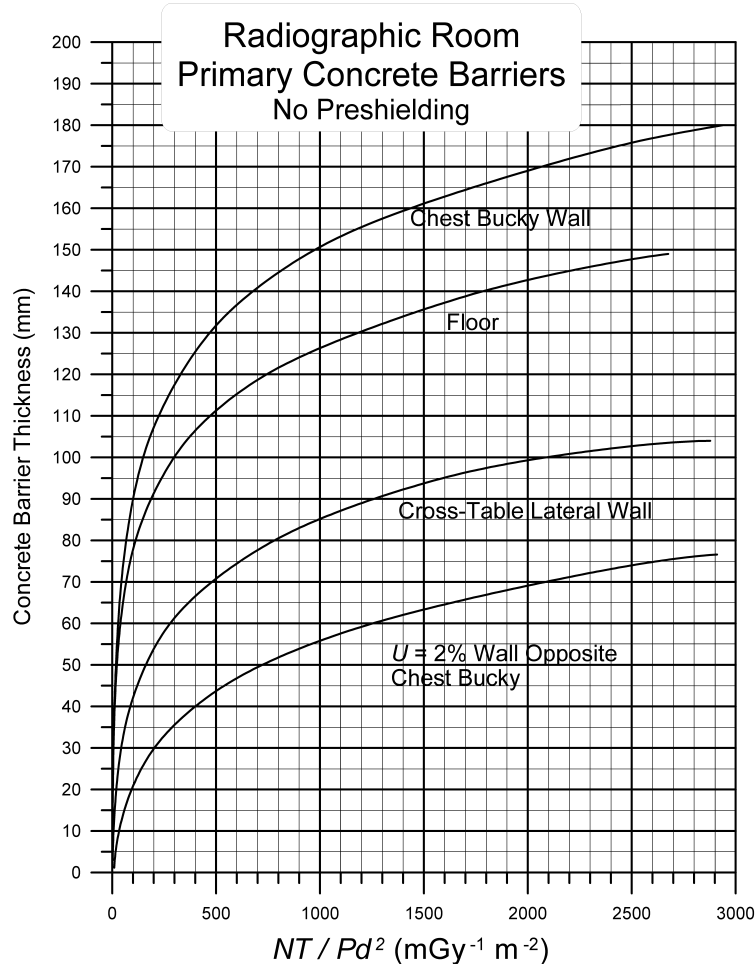

Fig. 4.6a. The concrete (standard-weight) thickness requirements for primary barriers assuming no preshielding (x_{pre}) in the representative radiographic room as a function of NT/Pd^2 . P is in milligray per week, N is the weekly total number of patients examined in the radiographic room, and d (in meters) is chosen as the distance from the most intense radiation source to the occupied area. If the W_{norm} values given in Table 4.5 do not match the per patient workload for the facility under consideration, then the original value of NT/Pd^2 can be multiplied by W_{site}/W_{norm} , and the modified value can be used to obtain the required shielding from Figure 4.6a.

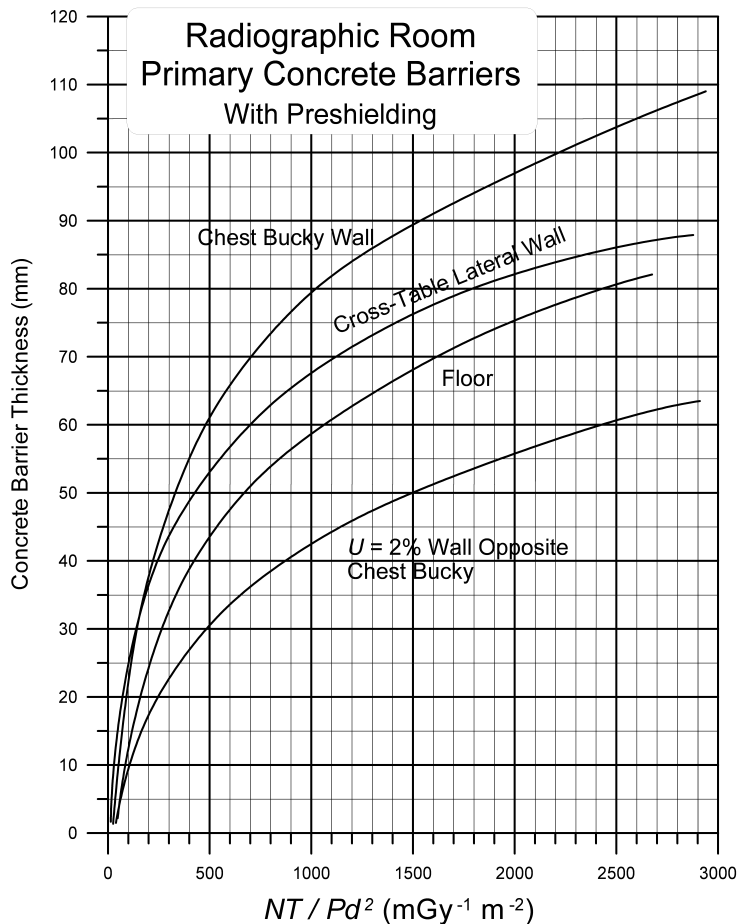

Fig. 4.6b. The concrete (standard-weight) thickness requirements for primary barriers assuming preshielding (x_{pre}) in the representative radiographic room as a function of NT/Pd^2 (see Section 4.1.6.2 for caveats on x_{pre}). P is in milligray per week, N is the weekly total number of patients examined in the radiographic room, and d (in meters) is chosen as the distance from the most intense radiation source to the occupied area. Image-receptor data as in Figure 4.5b. If the W_{norm} values given in Table 4.5 do not match the per patient workload for the facility under consideration, then the original value of NT/Pd^2 can be multiplied by W_{site}/W_{norm} , and the modified value can be used to obtain the required shielding from Figure 4.6b.

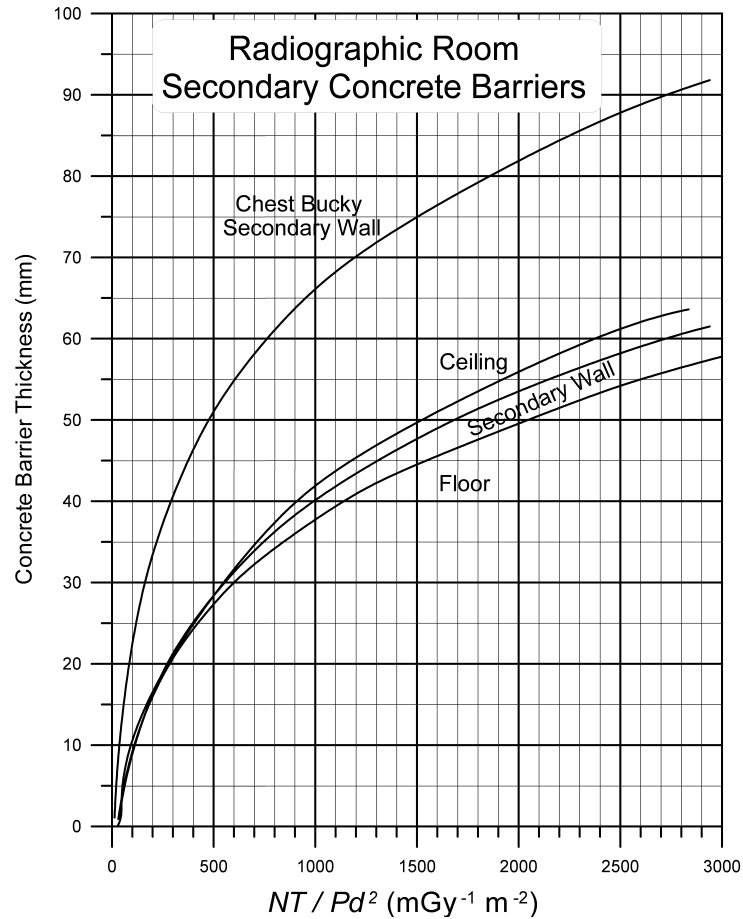

Fig. 4.6c. The concrete (standard-weight) thickness requirements for secondary barriers in the representative radiographic room as a function of NT/Pd^2 . P is in milligray per week, N is the weekly total number of patients examined in the radiographic room, and d (in meters) is chosen as the distance from the most intense radiation source to the occupied area. If the W_{norm} values given in Table 4.5 do not match the per patient workload for the facility under consideration, then the original value of NT/Pd^2 can be multiplied by W_{site}/W_{norm} , and the modified value can be used to obtain the required shielding from Figure 4.6c.

d should be judiciously chosen as that from the radiation source that contributes the most to the air kerma in the occupied area. For any barrier struck by a primary beam, d should be measured from the location of the x-ray tube delivering the primary radiation to that barrier. For barriers struck only by secondary radiation from the various tube orientations, it is reasonable to measure d from the center of the radiographic table.

In like manner, the barrier requirements for a representative R&F room are considered. Identical in shape and dimensions to the radiographic room considered above, this room includes an image intensifier (image-receptor area of 730 cm² at 0.8 m SID) centered over the procedure table. The fluoroscopy x-ray tube focal spot is assumed to be 0.5 m beneath the table surface. Fluoroscopic x-ray exposures were assumed to follow the *Fluoroscopy Tube (R&F room)* workload distribution (W_{norm} is 13 mA min patient⁻¹). Fluoroscopic examinations were also assumed to involve radiographic exposures directed at the procedure table (1,000 cm² image-receptor area at 1 m SID) following the *Rad Tube (R&F room)* workload distribution (W_{norm} is 1.5 mA min patient⁻¹). An R&F room is typically used for a significant number of radiographic-only patients, in addition to fluoroscopic examinations. Although it has been assumed for the representative R&F room that procedures on three radiography-only patients are performed for every procedure involving fluoroscopic examination, the shielding requirements do not depend strongly on the assumption of this ratio. For a value of 1,800 mGy⁻¹ m⁻² for NT/Pd^2 , reducing the ratio to 2:1 increases the shielding requirement by approximately two percent, while increasing the ratio to 4:1 decreases the shielding requirement by a similar amount. The workload distributions for the radiographic tube are the same as those assumed for the representative radiographic room. The required thicknesses of lead and concrete for the various barriers in the R&F room have been calculated and are shown in Figures 4.7 and 4.8 as a function of NT/Pd^2 . Again, P is in milligray per week, N is the total number of patients examined in the R&F room each week (Section 4.1.4), and d (in meters) should be chosen as the distance from the most intense radiation source to the occupied area.

The shielding thickness requirements for the barriers in the representative radiographic and R&F rooms for steel, gypsum wall-board, and plate glass can be estimated from the lead and concrete requirements in the shielding graphs in Figures 4.5 through 4.8. The use factors applied to generate the data for primary barriers in these figures are given in Table 4.4 and earlier in this Section.

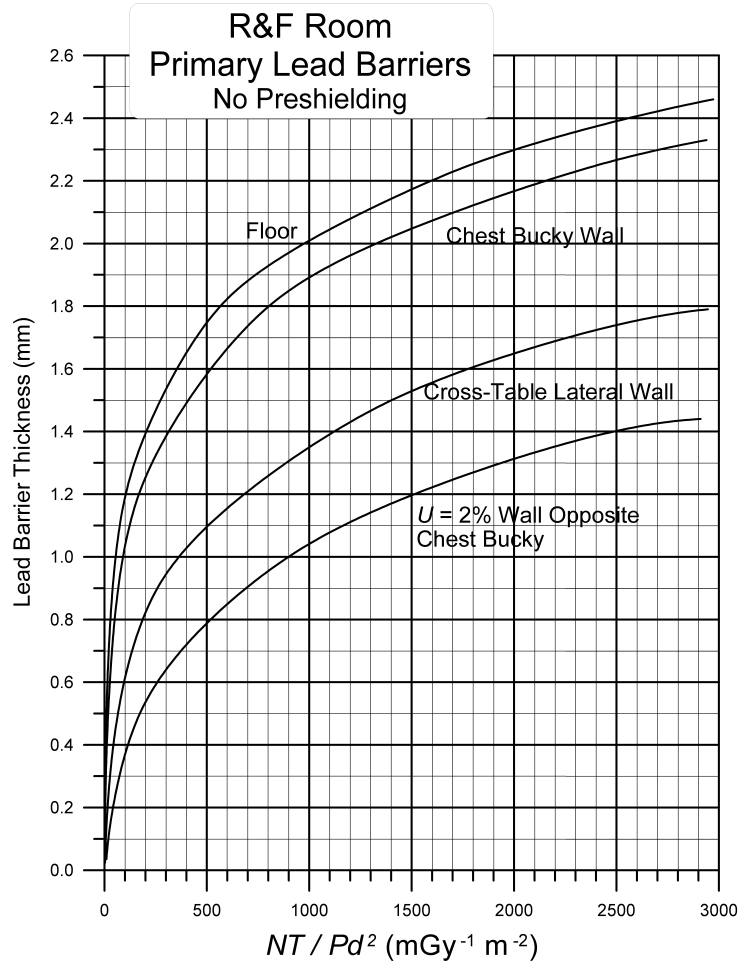

Fig. 4.7a. The lead thickness requirements for primary barriers assuming no preshielding (x_{pre}) in the representative R&F room shown as a function of NT/Pd^2 . P is in milligray per week, N is the weekly total number of patients examined in the R&F room, and d (in meters) is chosen as the distance from the most intense radiation source to the occupied area. If the W_{norm} values given in Table 4.5 do not match the per patient workload for the facility under consideration, then the original value of NT/Pd^2 can be multiplied by W_{site}/W_{norm} , and the modified value can be used to obtain the required shielding from Figure 4.7a.

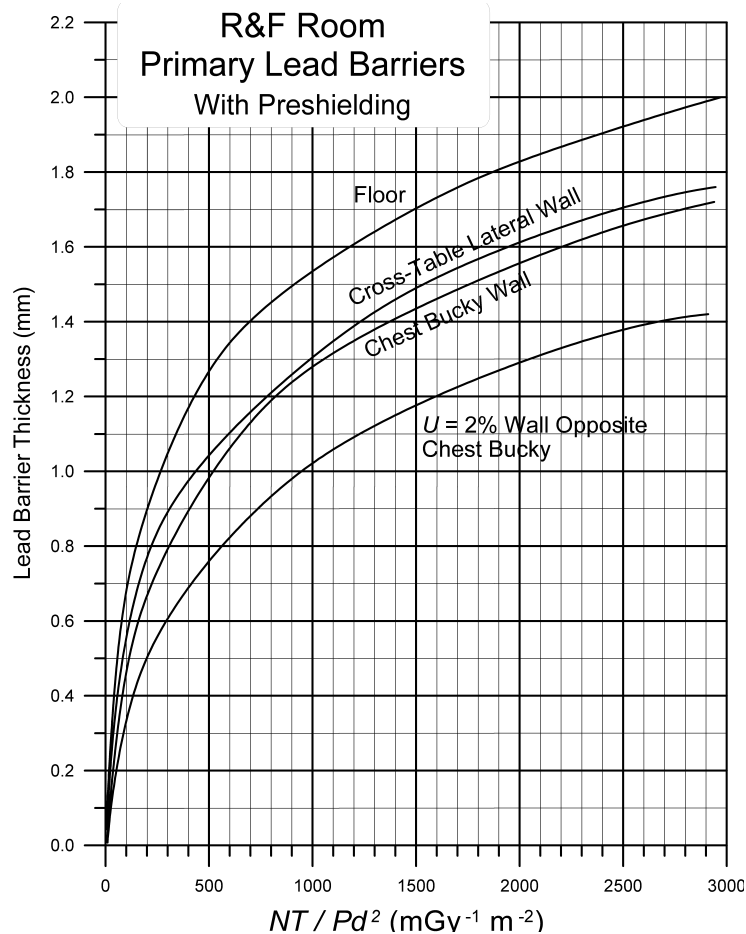

Fig. 4.7b. The lead thickness requirements for primary barriers assuming preshielding (x_{pre}) in the representative R&F room shown as a function of NT/Pd^2 (see Section 4.1.6.2 for caveats on x_{pre}). P is in milligray per week, N is the weekly total number of patients examined in the R&F room, and d (in meters) is chosen as the distance from the most intense radiation source to the occupied area. Image-receptor data as in Figure 4.5b. If the W_{norm} values given in Table 4.5 do not match the per patient workload for the facility under consideration, then the original value of NT/Pd^2 can be multiplied by W_{site}/W_{norm} , and the modified value can be used to obtain the required shielding from Figure 4.7b.

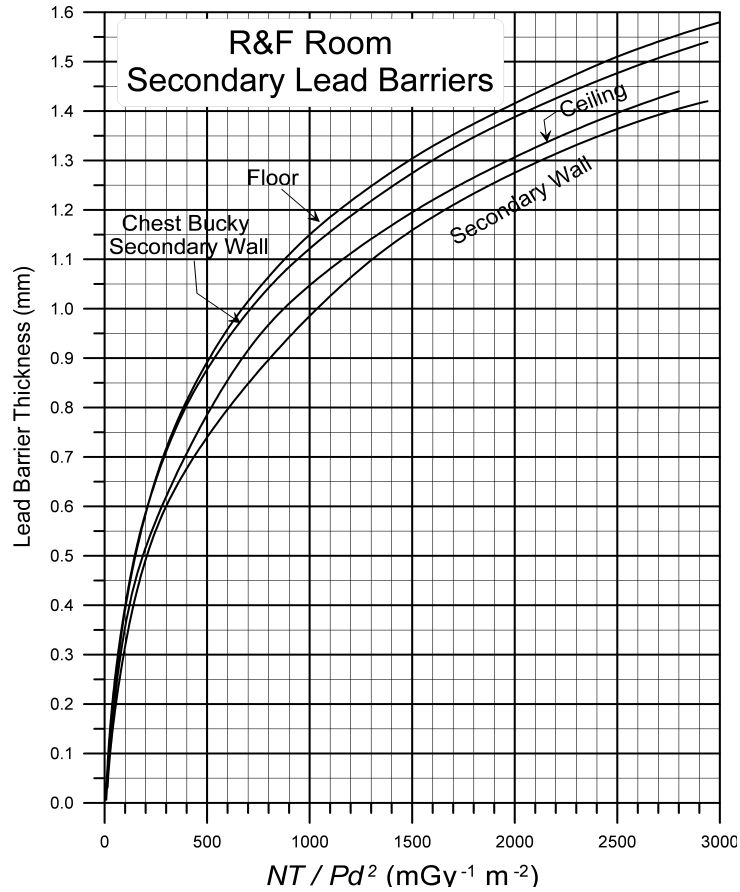

Fig. 4.7c. The lead thickness requirements for secondary barriers in the representative R&F room shown as a function of NT/Pd^2 . P is in milligray per week, N is the weekly total number of patients examined in the R&F room, and d (in meters) is chosen as the distance from the most intense radiation source to the occupied area. If the W_{norm} values given in Table 4.5 do not match the per patient workload for the facility under consideration, then the original value of NT/Pd^2 can be multiplied by $W_{\text{site}}/W_{\text{norm}}$, and the modified value can be used to obtain the required shielding from Figure 4.7c.

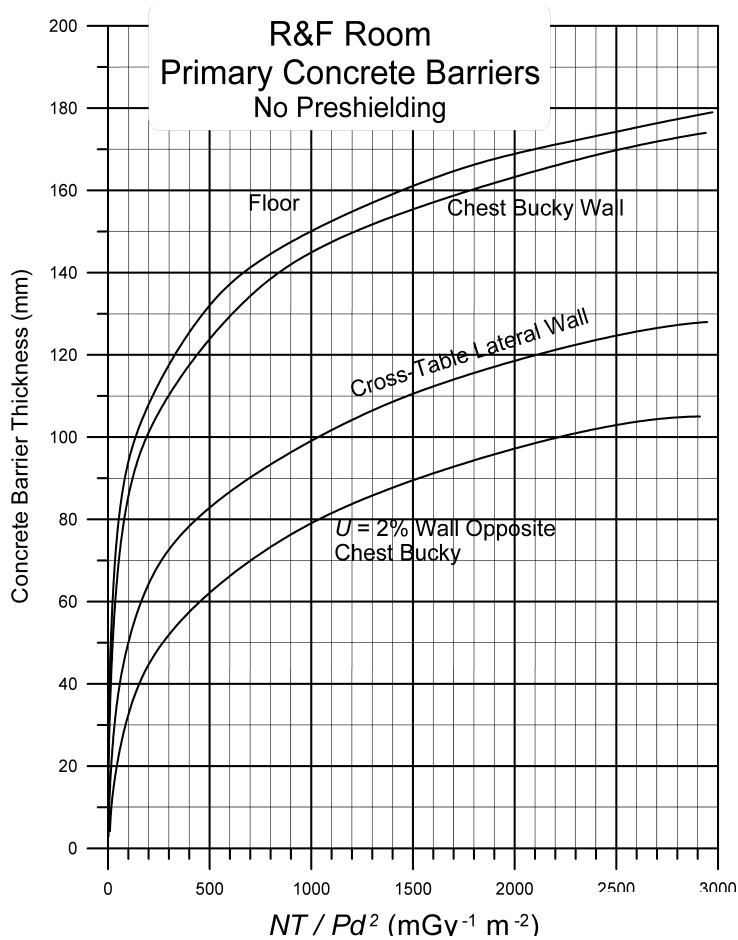

Fig. 4.8a. The concrete (standard-weight) thickness requirements for primary barriers assuming no preshielding (x_{pre}) in the representative R&F room shown as a function of NT/Pd^2 . P is in milligray per week, N is the weekly total number of patients examined in the R&F room, and d (in meters) is chosen as the distance from the most intense radiation source to the occupied area. If the W_{norm} values given in Table 4.5 do not match the per patient workload for the facility under consideration, then the original value of NT/Pd^2 can be multiplied by W_{site}/W_{norm} , and the modified value can be used to obtain the required shielding from Figure 4.8a.

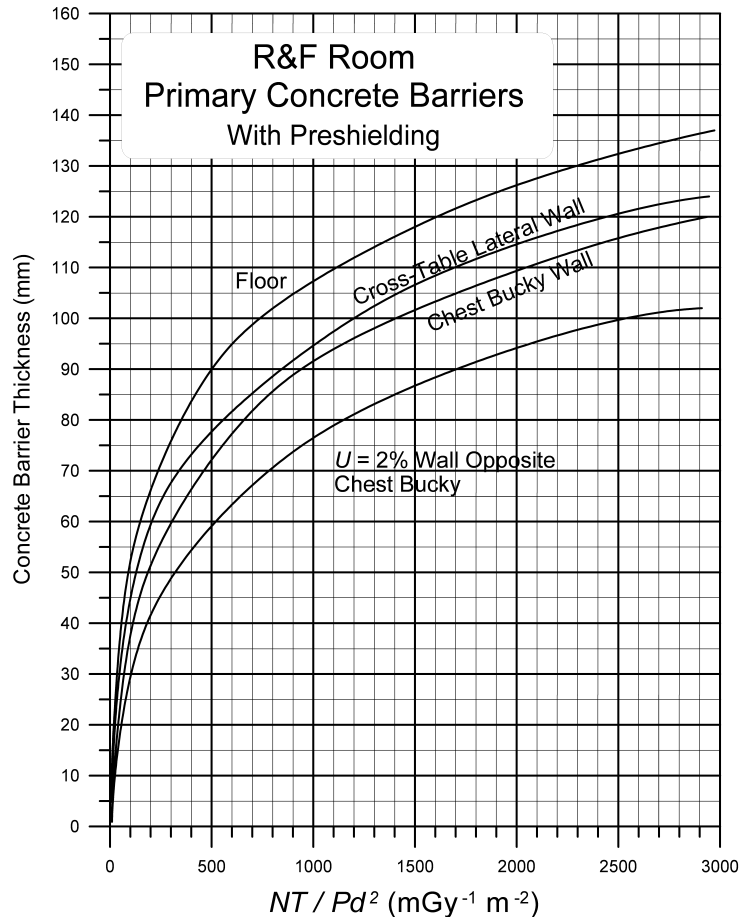

Fig. 4.8b. The concrete (standard-weight) thickness requirements for primary barriers assuming preshielding (x_{pre}) in the representative R&F room shown as a function of NT/Pd^2 (see Section 4.1.6.2 for caveats on x_{pre}). P is in milligray per week, N is the weekly total number of patients examined in the R&F room, and d (in meters) is chosen as the distance from the most intense radiation source to the occupied area. Image-receptor data as in Figure 4.5b. If the W_{norm} values given in Table 4.5 do not match the per patient workload for the facility under consideration, then the original value of NT/Pd^2 can be multiplied by $W_{\text{site}}/W_{\text{norm}}$, and the modified value can be used to obtain the required shielding from Figure 4.8b.

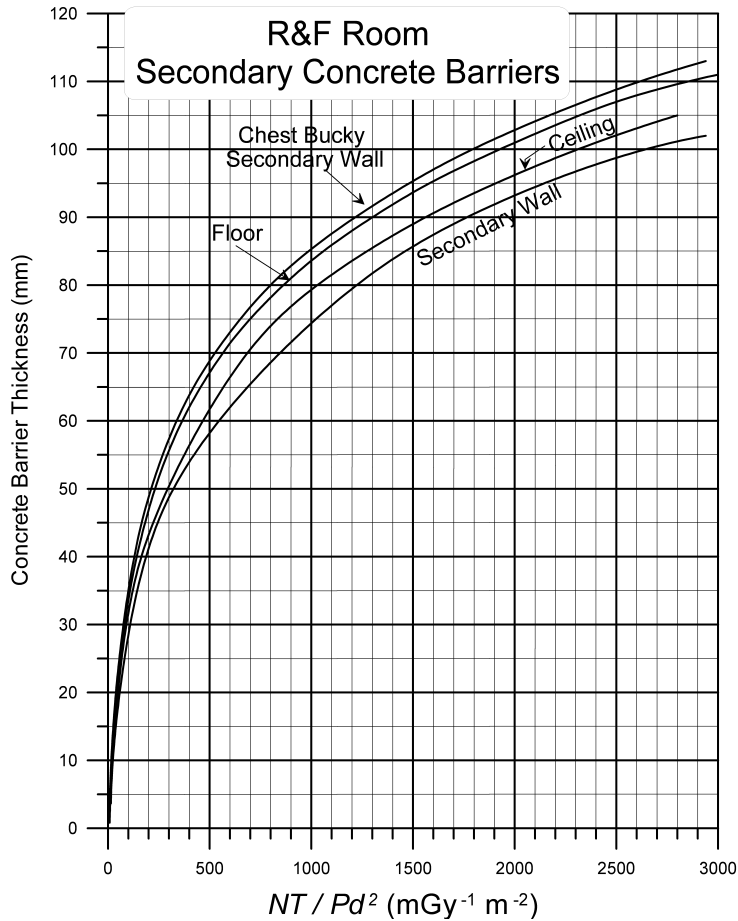

Fig. 4.8c. The concrete (standard-weight) thickness requirements for secondary barriers in the representative R&F room shown as a function of NT/Pd^2 . P is in milligray per week, N is the weekly total number of patients examined in the R&F room, and d (in meters) is chosen as the distance from the most intense radiation source to the occupied area. If the W_{norm} values given in Table 4.5 do not match the per patient workload for the facility under consideration, then the original value of NT/Pd^2 can be multiplied by $W_{\text{site}}/W_{\text{norm}}$, and the modified value can be used to obtain the required shielding from Figure 4.8c.

Table 4.8 contains factors which, when multiplied by the lead (or concrete) requirement, yields the approximate steel (or gypsum wallboard, plate glass, or light-weight concrete) thickness requirement. These factors are conservatively safe and apply to this specific use only. For example, assume that use of Figure 4.6 had required a 8 mm thick standard-weight concrete barrier. A gypsum wallboard barrier $3.2 \times 8 \text{ mm} = 26 \text{ mm}$ thick or a plate glass barrier $1.2 \times 8 \text{ mm} = 9.6 \text{ mm}$ thick would also suffice.

4.3 Uncertainties

Although the workload distributions used in this Report are based on a survey of medical institutions involving a large number of patient studies, it is conceivable that the introduction of new technologies or clinical practices may over time have an impact on the shapes of these distributions. It is, therefore, reasonable to consider what types of changes may occur and what their impact might be on the recommended shielding requirements.

The x-ray technique factors for a particular study are determined by minimizing patient exposure while achieving the required image contrast for acceptable clinical image quality. Since kVp is the single most important parameter in this relationship, the kVp values actually used for each specific type of study conform to a narrow distribution. For example, performing one of the most common interventional procedures, imaging blood vessels using iodine contrast media, requires that the operating potential typically not exceed approximately 85 kVp. Thus, the shape of the

TABLE 4.8—Barrier thickness requirements for steel, gypsum wallboard, and plate glass determined from lead and concrete requirements utilizing the shielding graphs in Figures 4.5 to 4.8 for both the representative radiographic and R&F rooms.^a

Steel thickness requirement	8 times the lead thickness requirement
Gypsum wallboard thickness requirement	3.2 times the standard-weight concrete thickness requirement
Plate glass thickness requirement	1.2 times the standard-weight concrete thickness requirement
Light-weight concrete thickness requirement	1.3 times the standard-weight concrete thickness requirement

^aThis Table is only applicable for conversion of a barrier thickness determined with the NT/Pd^2 model given in Figures 4.5 through 4.8.

distribution function for each type of study can be considered to be limited by the physics of imaging science and is unlikely to change appreciably over time. Accordingly, as long as the range of the types of studies performed in a given type of room does not change, then the workload distributions assumed in this Report will remain a sound basis for specifying shielding requirements.

It is anticipated that the introduction of new imaging technologies may require a change in the magnitude of the integral of the workload distribution. That is, the relative spread of workloads over kVp may remain similar to workload distributions published in this Report, but the total workload per patient (W_{norm}) may change. As discussed earlier, $W_{\text{site}}/W_{\text{norm}}$ is the scaling factor incorporated to accommodate this change.

There will be variations in the workload distributions between institutions due to variations in medical imaging equipment, image-receptor speed, and contrast requirements, etc. Simpkin (1996a) reported standard deviations in the value of the workload per patient for each 5 kVp-wide bin for the workload distributions used in this Report. These data form the basis for a sensitivity analysis that illustrates the impact that these variations have on shielding recommendations in this Report. As an example, if the magnitude of the workload per patient in each kVp bin for a radiographic room is increased by two standard deviations, the shielding for a primary barrier whose value of NT/Pd^2 is $3,000 \text{ mGy}^{-1} \text{ m}^{-2}$ would increase by <0.1 mm of lead. For other types of rooms and other barriers, the increase in the shielding recommendations is similar.

5. Examples of Shielding Calculations

This Section demonstrates how the theoretical information and data contained in this Report may be used to determine the minimum barrier thickness required to shield different types of medical x-ray imaging rooms. However, it is important to stress that these examples and the methodology used are not intended to represent the only techniques and assumptions capable of providing acceptable radiation protection. Alternate methods may prove equally satisfactory. The professional judgement of the qualified expert is required in each design specification to ensure that the necessary degree of radiation protection is achieved as effectively and economically as possible.

The final assessment of the adequacy of the design and construction of structural shielding is based on the radiation survey of the completed installation as described in Section 6 of this Report. To ensure that the appropriate shielding design goals for controlled and uncontrolled areas are not exceeded, direct measurements are recommended. If the assessment survey shows deficiencies, additional shielding or modification of equipment and procedures are required. To avoid such deficiencies, the qualified expert needs to consider the ALARA principal and use a conservatively safe approach in specifying radiation barriers. The cost of adding shielding to an existing facility is many times greater than increasing it in the initial phase of construction.

Table 5.1 provides a summary of the resources in this Report that are included to assist the qualified expert in specifying shielding requirements. For completeness and as an instructional tool, many of these examples contain more than one method of determining one particular barrier requirement. Figures 4.5, 4.6, 4.7 and 4.8, for example, provide a simplified method of finding the required thickness of each barrier in radiographic and R&F rooms. As shown in the examples, similar results for these barriers can be obtained using the figures in Appendices B and C with conventional computational methods. These computational methods are also employed for cardiac and peripheral angiography, and mammography rooms. Finally, the data and information contained in

TABLE 5.1—Summary guide to resources in this Report.

Room Designation	Barrier	Type of Radiation	Unshielded Air-Kerma Data	Transmission Data		
				Lead	Concrete	Other Materials
Radiographic room	Floor under x-ray table, cross-table, other primary walls, chest-bucky wall	Primary	Table 4.5	Figure 4.5a, Figure 4.5b, Figure B.2, Table B.1	Figure 4.6a, Figure 4.6b, Figure B.3, Table B.1	Table 4.8, Figures B.4 – B.6, Table B.1
		Secondary	Table 4.7	Figure 4.5c, Figure C.2, Table C.1	Figure 4.6c, Figure C.3, Table C.1	Table 4.8, Figures C.4 – C.7, Table C.1
R&F room	Floor under x-ray table, cross-table, other primary walls, chest-bucky wall	Primary	Table 4.5	Figure 4.7a, Figure 4.7b, Figure B.2, Table B.1	Figure 4.8a, Figure 4.8b, Figure B.3, Table B.1	Table 4.8, Figures B.4 – B.6, Table B.1
		Secondary	Table 4.7	Figure 4.7c, Figure C.2, Table C.1	Figure 4.8c, Figure C.3, Table C.1	Table 4.8, Figures C.4 – C.7, Table C.1

Dedicated chest room	Chest-bucky wall	Primary	Table 4.5	Figure B.2, Table B.1	Figure B.3, Table B.1	Figures B.4 – B.6, Table B.1
	All other barriers	Secondary	Table 4.7	Figure C.2, Table C.1	Figure C.3, Table C.1	Figures C.4 – C.7, Table C.1
Cardiac Angiography	All barriers	Secondary	Table 4.7	Figure C.2, Table C.1	Figure C.3, Table C.1	Figures C.4 – C.7, Table C.1
Peripheral angiography ^a	All barriers	Secondary	Table 4.7	Figure C.2, Table C.1	Figure C.3, Table C.1	Figures C.4 – C.7, Table C.1
Mammography	All barriers	Secondary	Table 4.7 Section 5.5	Figure C.2, Table C.1	Figure C.3, Table C.1	Figures C.4 – C.7, Table C.1
Computed tomography	All barriers	Secondary	Section 5.6	Figure A.2	Figure A.3	—

^aIn this Table, the resources cited for peripheral angiography also apply to neuroangiography.

the tables and graphs in these appendices can be readily employed in computer-based spreadsheet solutions.

The first example considers a straight-forward case of a single x-ray source with secondary barriers. The more complicated cases of multiple x-ray sources with variable beam locations will then be considered for radiographic and R&F rooms.

5.1 Cardiac Angiography

Consider a cardiac angiography suite in which 25 patients per week undergo procedures following the *Cardiac Angiography* workload distribution in Table 4.2. Note that only secondary radiation needs to be considered, as the image-intensifier assembly acts as a primary beam stop in this case. Assume an uncontrolled area ($P = 0.02 \text{ mGy week}^{-1}$), fully occupied ($T = 1$) at a distance $d = 4 \text{ m}$ from the isocenter of the x-ray unit. For this example, the scattered radiation contribution to the secondary air kerma is assumed to be from the conservatively high forward/back direction that gives a total secondary air kerma (K_{sec}^1) of $3.8 \text{ mGy patient}^{-1}$ at 1 m (Table 4.7). The weekly unshielded air kerma at $d_{\text{sec}} = 4 \text{ m}$ (from Equation 4.4) is then:

$$K_{\text{sec}}(0) = \frac{3.8 \text{ mGy patient}^{-1} \times 25 \text{ patients week}^{-1}}{(4 \text{ m})^2} = 5.9 \text{ mGy week}^{-1}.$$

The required shielding barrier transmission is therefore:

$$B_{\text{sec}}(x_{\text{barrier}}) = \frac{0.02 \text{ mGy week}^{-1}}{5.9 \text{ mGy week}^{-1}} = 3.4 \times 10^{-3}.$$

From Figure C.2 in Appendix C, a lead barrier 1.3 mm thick will provide adequate shielding.

Equivalently, using the above values for N , T , P , d_{sec} , K_{sec}^1 , and the fitting parameters (α , β and γ) for the secondary transmission for the *Cardiac Angiography* workload distribution (from Table C.1) in Equation 4.10 yields a lead barrier of the same thickness. An example for $P = 0.02 \text{ mGy week}^{-1}$ is:

$$x_{\text{barrier}} = \frac{1}{2.354 \times 0.7481} \ln \left[\frac{\left(\frac{25 \times 1 \times 3.8}{0.02 \times 4^2} \right)^{0.7481} + \frac{14.94}{2.354}}{1 + \frac{14.94}{2.354}} \right] = 1.3 \text{ mm}.$$

The nearest commercially available lead sheet $\geq 1.3 \text{ mm}$ thickness is 1/16 inch (1.58 mm) (Figure 2.3).

5.2 Dedicated Chest Unit

Next, consider shielding two barriers of a dedicated chest unit that is used to image 300 patients per week. Typically, there is a wall behind the chest image receptor that is a primary barrier and an adjacent (perpendicular) wall that is a secondary barrier. Assume that the x-ray beam in this room is always directed horizontally toward a wall-mounted chest-bucky image receptor of area $1,535 \text{ cm}^2$ (at 1.83 m SID), and that the kVp distribution of workloads follows that of the *Chest Room* in Table 4.2.

Let the room behind the image-receptor wall be a fully-occupied, uncontrolled office, so that $P/T = 0.02 \text{ mGy week}^{-1}$. Assume a primary distance $d_p = 3 \text{ m}$. The wall on which the image receptor is mounted will therefore serve as a primary barrier to the x-ray beam with a use factor $U = 1$. Substituting these values and the primary air kerma per patient from Table 4.5 into Equation 4.3, the weekly unshielded primary air kerma in this occupied area is:

$$K_p(0) = \frac{1.2 \text{ mGy patient}^{-1} \times 1 \times 300 \text{ patients week}^{-1}}{(3 \text{ m})^2} = 40 \text{ mGy week}^{-1}.$$

The transmission required for the primary barriers is therefore:

$$B_p(x_{\text{barrier}} + x_{\text{pre}}) = \frac{0.02 \text{ mGy week}^{-1}}{40 \text{ mGy week}^{-1}} = 5 \times 10^{-4}.$$

From Figure B.2 for a dedicated chest unit, this transmission is achieved with 2.2 mm lead. The thickness of lead required in the wall (x_{barrier}) may be determined by subtracting from this total requirement the image-receptor preshielding thickness (x_{pre}) for a wall-mounted chest bucky. From Table 4.6, $x_{\text{pre}} = 0.85 \text{ mm}$ lead. Therefore, the value for the wall barrier thickness, accurate to two significant figures is $x_{\text{barrier}} = (2.2 - 0.85 \text{ mm}) = 1.4 \text{ mm}$ lead. If x_{pre} is used, the nearest standard lead thickness greater than this (*i.e.*, 1.58 mm or 1/16 inch) should be specified.

Equivalently, the above values for N , T , U , P , d_p , K_p^1 , x_{pre} , and the fitting parameters (α , β and γ) for the primary transmission for the *Chest Room* workload distribution (from Table B.1) may be used in Equation 4.8:

$$x_{\text{barrier}} + x_{\text{pre}} = \frac{1}{2.283 \times 0.6370} \ln \left[\frac{\left(\frac{300 \times 1 \times 1 \times 1.2}{0.02 \times 3^2} \right)^{0.6370} + \frac{10.74}{2.283}}{1 + \frac{10.74}{2.283}} \right] = 2.2 \text{ mm}.$$

As before, if x_{pre} (0.85 mm lead) is subtracted from this value, the same result (1.4 mm lead) is obtained.

Now, consider a wall adjacent to the wall on which the chest image receptor in the chest room is mounted. This wall is never struck by the primary beam and is therefore a secondary barrier. Assume a fully occupied, uncontrolled ($P/T = 0.02 \text{ mGy week}^{-1}$) area located a distance $d_{\text{sec}} = 2.1 \text{ m}$ from both the patient and x-ray tube. From Table 4.7, the total unshielded secondary air kerma for leakage plus 90 degree scatter (side-scatter) at 1 m from the chest unit is $2.7 \times 10^{-3} \text{ mGy patient}^{-1}$. Then, from Equation 4.4, the weekly unshielded secondary air kerma would be:

$$K_{\text{sec}}(0) = \frac{2.7 \times 10^{-3} \text{ mGy patient}^{-1} \times 300 \text{ patients week}^{-1}}{(2.1 \text{ m})^2} = 0.18 \text{ mGy week}^{-1}.$$

The secondary barrier transmission is therefore:

$$B_{\text{sec}}(x_{\text{barrier}}) = \frac{0.02 \text{ mGy week}^{-1}}{0.18 \text{ mGy week}^{-1}} = 1.1 \times 10^{-1}.$$

From Figure C.2, this transmission would be obtained for a dedicated chest unit by a 0.42 mm thick lead barrier. As before, the calculation can also be made using Equation 4.10 and the secondary transmission fitting parameters (α , β and γ) from Table C.1:

$$x_{\text{barrier}} = \frac{1}{2.288 \times 1.054} \ln \left[\frac{\left(\frac{300 \times 1 \times 0.0027}{0.02 \times 2.1^2} \right)^{1.054} + \frac{9.848}{2.288}}{1 + \frac{9.848}{2.288}} \right] = 0.42 \text{ mm}.$$

The nearest commercially available lead sheet $\geq 0.42 \text{ mm}$ sheet is 1/32 inch (0.79 mm) (Figure 2.3). Again the adequacy of both the primary and secondary barriers in achieving the effective dose limit for members of the public is confirmed by means of the performance assessment by the qualified expert.

5.3 The Radiographic Room

Consider next the radiographic room in Figure 5.1 (elevation drawing) and Figure 5.2 (plan drawing). Assume $N = 125$ patients per week are radiographed in this room. The workload distribution is assumed to follow that of the radiographic room from the AAPM-TG9 survey (Simpkin, 1996a). The areas exposed to primary radiation include the office beneath the floor, the staff rest room adjacent to the chest image receptor, and the cross-table wall

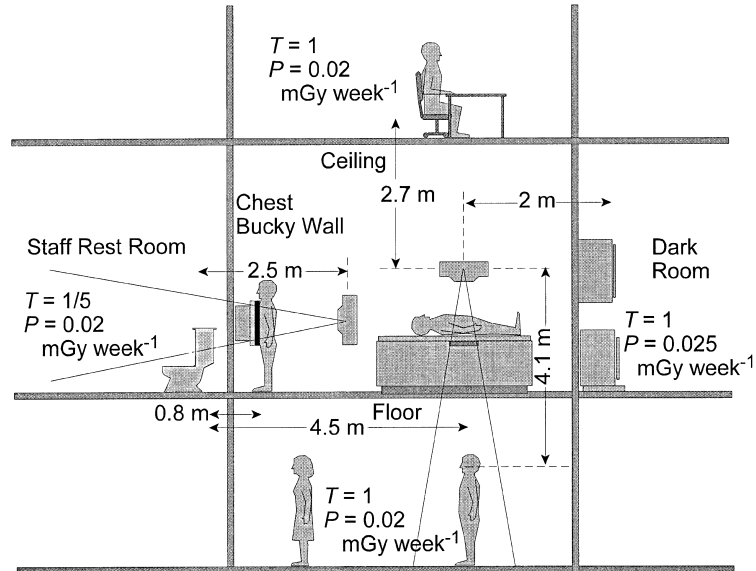

Fig. 5.1. Elevation drawing of the radiographic room. The dimensions are used in sample calculations in Section 5.3. This same layout is also used for the R&F room examples in Section 5.4, with the addition of a fluoroscopy x-ray tube beneath the table and an image intensifier over the table.

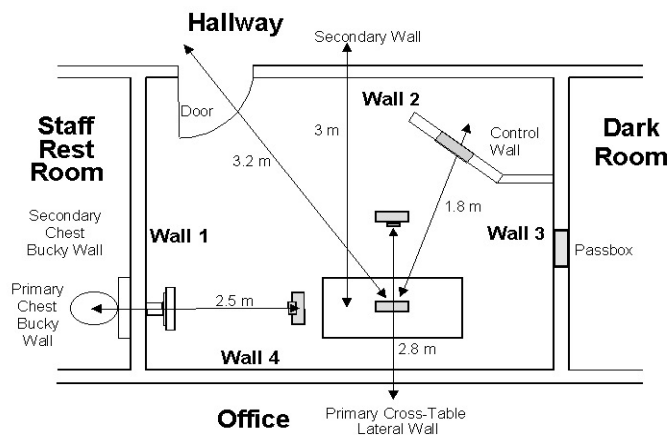

Fig. 5.2. Plan drawing of the radiographic room shown in Figure 5.1.

(Wall 4 behind the x-ray table as shown in Figure 5.2). All other areas are assumed to be exposed only to secondary radiation. The values for other shielding parameters that need to be determined by the qualified expert for this room are noted either in Figure 5.1, Figure 5.2, or in the examples.

5.3.1 The Floor of the Radiographic Room

Assume the area below the radiographic room is an uncontrolled area with a shielding design goal of $P = 0.02 \text{ mGy week}^{-1}$ with an occupancy factor $T = 1$. This area will be irradiated by primary radiation directed at the image receptor in the radiographic table, as well as by secondary radiation.

5.3.1.1 Primary Barrier Calculation for Floor Beneath the Radiographic Table. From Table 4.5, the unshielded primary air kerma per patient for the *Rad Room (floor or other barriers)* workload distribution is $5.2 \text{ mGy patient}^{-1}$ at 1 m. While the use factor (U) for this workload distribution directed on the floor is 0.89 (Table 4.4), one may use a conservatively safe assumption that $U = 1$. Thus, at the location 1.7 m above the lower floor (Section 4.1.2) (*i.e.*, $d_p = 4.1 \text{ m}$), the total unshielded primary air kerma per week, from Equation 4.3, is:

$$K_p(0) = \frac{5.2 \text{ mGy patient}^{-1} \times 1 \times 125 \text{ patients week}^{-1}}{(4.1 \text{ m})^2} = 39 \text{ mGy week}^{-1}.$$

The primary barrier transmission required for $T = 1$ and $P = 0.02 \text{ mGy week}^{-1}$ is:

$$B_p(x_{\text{barrier}} + x_{\text{pre}}) = \frac{0.02 \text{ mGy week}^{-1}}{39 \text{ mGy week}^{-1}} = 5.1 \times 10^{-4}.$$

Use of the primary transmission curve for concrete (Figure B.3) for the *Rad Room (floor or other barriers)* workload distribution, results in a required total thickness ($x_{\text{barrier}} + x_{\text{pre}}$) of 107 mm concrete. From Table 4.6, the attenuation provided by a typical radiographic table and image receptor (ignoring patient attenuation) is equivalent to 72 mm concrete. Thus, $x_{\text{pre}} = 72 \text{ mm}$ concrete and the net thickness required in the floor under the x-ray table to attenuate the primary beam is $x_{\text{barrier}} = (107 - 72 \text{ mm}) = 35 \text{ mm}$. These results may also be obtained from Equation 4.8 using the fitting parameters in Table B.1 for the primary beam transmission for the *Rad Room (floor or other barriers)* workload distribution.

This result may also be quickly arrived at using the method described in Section 4.2.4. Using the same parameters as before, the first step is to determine the value of NT/Pd^2 :

$$\frac{NT}{Pd^2} = \frac{125 \text{ patients week}^{-1} \times 1}{0.02 \text{ mGy week}^{-1} \times (4.1 \text{ m})^2} = 372 \text{ mGy}^{-1} \text{ m}^{-2}.$$

Then, using this value and Figure 4.6b (to account for the attenuation from the image receptor and radiographic table), a net barrier thickness of 37 mm concrete is required. This calculation includes the secondary radiation present from procedures done against the chest bucky and cross-table lateral work. This result is similar to the 35 mm concrete barrier calculated previously. However, the first calculation only considered the primary beam contribution from the over-table tube.

5.3.1.2 Secondary Barrier Calculation for Floor. Floor areas away from the table need to serve as a secondary barrier for exposures directed at the patient on the table and chest image receptor and their shielding adequacy needs to be verified. For example, shielding required at the location of the woman in Figure 5.1 needs to be determined. There are two independent secondary radiation sources that need to be considered, namely the patient on the radiographic table and the patient against the chest image receptor. Note that this secondary radiation will be assumed to impact the floor directly without attenuation by the table-mounted image-receptor hardware. The workload distribution *Rad Room (all barriers)* that includes scattered and leakage radiations from both sources is utilized. A conservatively safe assumption is that the x-ray tube is located so that the scattered and leakage radiation distances are equal to the vertical distance from the patient to the location of the woman in Figure 5.1 (*i.e.*, $d_S \approx d_L \approx d_{\text{sec}} = 3 \text{ m}$) (3 m not indicated on Figure 5.1). From Table 4.7, the total unshielded secondary air kerma per patient at 1 m, using the *Rad Room (all barriers)* workload distribution for leakage plus 90 degree scatter (side-scatter), is $3.4 \times 10^{-2} \text{ mGy}$. Thus, from Equation 4.4, the unshielded secondary air kerma for 125 patients per week is:

$$K_{\text{sec}}(0) = \frac{3.4 \times 10^{-2} \text{ mGy patient}^{-1} \times 125 \text{ patients week}^{-1}}{(3 \text{ m})^2} = 0.47 \text{ mGy week}^{-1}.$$

To reduce this to $0.02 \text{ mGy week}^{-1}$, a secondary barrier transmission of:

$$B_{\text{sec}}(x_{\text{barrier}}) = \frac{0.02 \text{ mGy week}^{-1}}{0.47 \text{ mGy week}^{-1}} = 4.3 \times 10^{-2}$$

is required. Using Figure C.3 for the transmission of secondary radiation through concrete and utilizing the curve for the *Rad Room (all barriers)* workload distribution, the concrete floor thickness required beyond the radiographic table is 33 mm. Hence, the 35 mm concrete thickness required from the primary barrier calculation under the radiographic table will suffice for the entire floor.

This result can be reproduced using the method described in Section 4.2.4. Here $d = 3$ m. As before, first determine the value of NT/Pd^2 :

$$\frac{NT}{Pd^2} = 694 \text{ mGy}^{-1} \text{ m}^{-2}.$$

Then, using Figure 4.6c for the off-table secondary floor, it is seen that a barrier thickness of 33 mm concrete is again found.

5.3.2 The Ceiling of a Radiographic Room

This area is uncontrolled ($P = 0.02 \text{ mGy week}^{-1}$) with an occupancy factor $T = 1$. This barrier is purely a secondary barrier. Assume, as above, that only one x-ray tube location is needed, with $d_L = 2.7$ m and $d_S = 3.5$ m (3.5 m not indicated on Figure 5.1). To be conservatively safe, set $d_S = d_L = d_{\text{sec}} = 2.7$ m. Assuming leakage plus forward/backscatter (a conservatively high assumption) from Table 4.7, it is found that the total unshielded air kerma per patient is $4.9 \times 10^{-2} \text{ mGy}$ for the *Rad Room (all barriers)* workload distribution. The unshielded total air kerma, from Equation 4.4, is then:

$$K_{\text{sec}}(0) = \frac{4.9 \times 10^{-2} \text{ mGy patient}^{-1} \times 125 \text{ patients week}^{-1}}{(2.7 \text{ m})^2} = 0.84 \text{ mGy week}^{-1}.$$

To reduce this to $0.02 \text{ mGy week}^{-1}$ requires a secondary barrier transmission of:

$$B_{\text{sec}}(x_{\text{barrier}}) = \frac{0.02 \text{ mGy week}^{-1}}{0.84 \text{ mGy week}^{-1}} = 2.4 \times 10^{-2}.$$

Figure C.3 in Appendix C then yields a required barrier thickness of 44 mm concrete for the ceiling. Note that the distance from the patient to the occupied area (d_S) was assumed to be the same distance as the distance from the x-ray tube head (d_L), the closer of the two sources of secondary radiation.

Alternatively, using the method of Section 4.2.4 and $d = 2.7$ m for this barrier, then:

$$\frac{NT}{Pd^2} = 857 \text{ mGy}^{-1} \text{ m}^{-2}.$$

From Figure 4.6c, the required ceiling thickness is found to be 39 mm of concrete. This result is slightly lower than that calculated previously, since Figure 4.6c was generated using more accurate distances from the patient at the chest bucky and the table to the ceiling. These slightly greater distances diminish the scattered radiation contribution to the air kerma at the ceiling, thereby allowing a thinner barrier.

5.3.3 Wall Containing the Chest Image Receptor in the Radiographic Room

As shown in Figure 5.1, the area behind the chest image receptor is a staff rest room. Since employees who do not work with radiation sources also use this rest room, the shielding design goal for an uncontrolled area applies, namely $P = 0.02 \text{ mGy week}^{-1}$. From Table 4.1, the suggested occupancy factor for a staff rest room is $T = 1/5$. Therefore, $P/T = 0.1 \text{ mGy week}^{-1}$.

5.3.3.1 Primary Barrier: Chest Image Receptor. The use factor for the *Rad Room (chest bucky)* workload distribution is $U = 1$ for exposures made on the chest image receptor. As explained in Section 4.1.4, N is also 125 patients week^{-1} for this barrier. Using Table 4.5 with the *Rad Room (chest bucky)* workload distribution, the weekly unshielded primary air kerma at 2.5 m from the chest tube position, from Equation 4.3, is:

$$K_p(0) = \frac{2.3 \text{ mGy patient}^{-1} \times 1 \times 125 \text{ patients week}^{-1}}{(2.5 \text{ m})^2} = 46 \text{ mGy week}^{-1}.$$

The primary barrier transmission is then:

$$B_p(x_{\text{barrier}} + x_{\text{pre}}) = \frac{0.1 \text{ mGy week}^{-1}}{46 \text{ mGy week}^{-1}} = 2.2 \times 10^{-3}.$$

From Figure B.2, the required total ($x_{\text{barrier}} + x_{\text{pre}}$) lead thickness for this workload distribution is 1.3 mm. From Table 4.6, the attenuation provided by a typical wall-mounted image receptor is equivalent to $x_{\text{pre}} = 0.85$ mm of lead. The recommended wall shielding therefore would be $x_{\text{barrier}} = 0.45$ mm lead, and 0.79 mm (1/32 inch) lead (the thinnest available thickness of sheet lead) should be specified.

One may also use the methodology of Section 4.2.4. Here $d = 2.5$ m from the chest x-ray tube to the occupied area. Then:

$$\frac{NT}{Pd^2} = 200 \text{ mGy}^{-1} \text{ m}^{-2}.$$

From Figure 4.5b, a barrier of 0.5 mm lead is indicated. This is in agreement with the calculation above.

5.3.3.2 Secondary Barrier: Chest Image-Receptor Wall. The area of the staff rest room that is outside the primary beam is irradiated by secondary radiation that is not attenuated by the chest image receptor. There are two scattered and leakage radiation sources to consider. One is the secondary radiation generated by the over-table exposures. The other is the secondary radiation from exposures made against the chest image receptor itself.

The unshielded secondary air kerma from the over-table x-ray tube location can be determined using Table 4.7. Assume leakage radiation plus side-scattered radiation, and the *Rad Room (floor or other barriers)* workload distribution with $d_{\text{sec}} = 4.5$ m. Then, from Equation 4.4:

$$K_{\text{sec}}(0) = \frac{2.3 \times 10^{-2} \text{ mGy patient}^{-1} \times 125 \text{ patients week}^{-1}}{(4.5 \text{ m})^2} = 0.14 \text{ mGy week}^{-1}.$$

The scattered and leakage radiations due to exposures made against the chest image receptor should be considered independently, since the scattered and leakage radiation distances are significantly different. Let the scattered radiation distance from the patient against the chest image receptor to the occupied area be $d_S = 0.8$ m. The leakage radiation distance from the x-ray tube to this area is $d_L = 2.5$ m. Then from Table 4.7, for the *Rad Room (chest bucky)* workload distribution, the unshielded side-scattered and leakage air kermas from these sources are 4.9×10^{-3} and 3.9×10^{-4} mGy patient⁻¹, respectively. From Equation 4.4, the sum of these contributions is:

$$K_{\text{sec}}(0) = \left[\frac{4.9 \times 10^{-3} \text{ mGy patient}^{-1}}{(0.8 \text{ m})^2} + \frac{3.9 \times 10^{-4} \text{ mGy patient}^{-1}}{(2.5 \text{ m})^2} \right] \times 125 \text{ patients week}^{-1}$$

or

$$K_{\text{sec}}(0) = 0.96 + 0.008 = 0.97 \text{ mGy week}^{-1}.$$

To this sum is added the previously calculated secondary radiation from the over-table tube location. Thus, the total unshielded secondary air kerma is:

$$K_{\text{sec}}(0) = 0.97 + 0.14 = 1.1 \text{ mGy week}^{-1}.$$

and the required barrier transmission factor is:

$$B(x_{\text{barrier}}) = \frac{0.1 \text{ mGy week}^{-1}}{1.1 \text{ mGy week}^{-1}} = 9.1 \times 10^{-2}.$$

The greatest contribution to the secondary air kerma is due to exposures against the chest bucky. Therefore, for simplicity and to be conservatively safe, assume the more penetrating *Rad Room (chest bucky)* workload distribution. From Figure C.2, a barrier of 0.35 mm lead is required. A more realistic calculation using the correct location for each scattered or leakage radiation source and a 30 degree scattering angle for the chest source with the correct workload distribution for each tube location yields 0.3 mm lead.

One may also use the shielding graphs from Section 4.2.4. Here $d = 2.5$ m from the chest tube to the occupied area. Substituting $N = 125$ patients week⁻¹ and $P/T = 0.1$ mGy week⁻¹ then:

$$\frac{NT}{Pd^2} = 200 \text{ mGy}^{-1} \text{ m}^{-2}.$$

From Figure 4.5c, a barrier of 0.37 mm lead is obtained, which is in good agreement with the values given above.

Since the primary shielding is greater than the secondary wall requirements, the entire wall can be shielded with a minimum of the primary requirement, 0.45 mm or 1/32 inch lead, the nearest greater standard thickness.

5.3.4 Darkroom Wall in the Radiographic Room

In shielding a darkroom, the limiting factor is usually the exposure to the film stored in the darkroom rather than to personnel occupying the darkroom. The recommended limit for unexposed film stored in boxes or in the film bin is an air kerma of 0.1 mGy during the storage period (Suleiman *et al.*, 1995). Assuming a one-month storage period, this is 0.025 mGy week⁻¹. Note that, since film storage shelving is often located higher than the usual shielding height of 2.1 m above the floor, it may be desirable to extend the shielding in this wall to at least 2.5 m above the floor.

For the radiographic room in Figure 5.1, assume that no exposures are made with the primary beam directed toward the darkroom wall, so that only secondary radiation need be considered. For simplicity, assume that all secondary radiation is generated with the x-ray tube over the table at a secondary distance of 2 m. The *Rad Room (all barriers)* workload distribution is appropriate for this case. Then, from Table 4.7 using the value for leakage radiation plus side-scattered radiation, the unshielded secondary air kerma in the darkroom is, from Equation 4.4:

$$K_{\text{sec}}(0) = \frac{3.4 \times 10^{-2} \text{ mGy patient}^{-1} \times 125 \text{ patients week}^{-1}}{(2 \text{ m})^2} = 1.1 \text{ mGy week}^{-1}.$$

The required barrier will have transmission:

$$B_{\text{sec}}(x_{\text{barrier}}) = \frac{0.025 \text{ mGy week}^{-1}}{1.1 \text{ mGy week}^{-1}} = 2.3 \times 10^{-2}.$$

The required shielding from Figure C.2 is therefore 0.53 mm lead.

In like manner, the shielding curves from Section 4.2.4 (Figure 4.5c) may be used. Letting $d = 2$ m for this darkroom wall:

$$\frac{NT}{Pd^2} = 1,250 \text{ mGy}^{-1} \text{ m}^{-2}.$$

From Figure 4.5c for a secondary wall, a barrier with a thickness of 0.53 mm lead is required as before.

The film passbox between the darkroom and the radiographic room will typically contain unexposed film loaded in cassettes. This greatly increases the sensitivity of the film to radiation-induced fogging by factors in excess of 100 (Suleiman *et al.*, 1995). Assuming that all the cassettes in the passbox will be recycled in 1 d (*e.g.*, once every 25 patients), the unshielded air kerma over 1 d to a cassette in the passbox would then be:

$$K_{\text{sec}}(0) = \frac{3.4 \times 10^{-2} \text{ mGy patient}^{-1} \times 25 \text{ patients}}{(2 \text{ m})^2} = 0.21 \text{ mGy}.$$

Assuming an air kerma of 0.5 μGy (5×10^{-4} mGy) will fog a film in a cassette (Suleiman *et al.*, 1995), the shielding for these cassettes requires a transmission of not more than:

$$B_{\text{sec}}(x_{\text{barrier}}) = \frac{5 \times 10^{-4} \text{ mGy}}{0.21 \text{ mGy}} = 2.3 \times 10^{-3}.$$

From Figure C.2, this requires a lead barrier thickness of 1.3 mm on all sides (except the darkroom side) of the film passbox.

5.3.5 The Cross-Table Wall in the Radiographic Room

Now consider the wall behind the x-ray table (Wall 4 in Figure 5.2) referred to as the cross-table wall. Radiographic exposures will be directed at this wall with only the patient, grid and cassette in the primary beam. However, only a small fraction of the exposures made on the 125 patients per week will be imaged using the cross-table alignment. From Table 4.4, the use factor U for such a wall is 0.09. This is applied to the *Rad Room (floor or other barriers)* workload distribution. Assume the wall protects a fully occupied, uncontrolled office ($P/T = 0.02 \text{ mGy week}^{-1}$) at primary distance $d_p = 2.8 \text{ m}$ from the x-ray tube. From Equation 4.3, the unshielded air kerma is:

$$K_p(0) = \frac{5.2 \text{ mGy patient}^{-1} \times 0.09 \times 125 \text{ patients week}^{-1}}{(2.8 \text{ m})^2} = 7.5 \text{ mGy week}^{-1}.$$

The required transmission for this wall is therefore:

$$B_p(x_{\text{barrier}} + x_{\text{pre}}) = \frac{0.02 \text{ mGy week}^{-1}}{7.5 \text{ mGy week}^{-1}} = 2.7 \times 10^{-3}.$$

From Figure B.2, the total lead thickness required to achieve this transmission is 0.9 mm lead. From Table 4.6, the lead-equivalent thickness of the grid- and cassette-image receptor (x_{pre}) is 0.3 mm. If proper collimation is assumed, the structural barrier thickness is then $x_{\text{barrier}} = (0.9 - 0.3 \text{ mm}) = 0.6 \text{ mm}$ lead.

However, this is not the total barrier requirement. Secondary radiation from the vertically directed beam can also reach the same areas as the primary cross-table beam. This secondary radiation may not be negligible compared to the primary due to the low-primary beam use factor and the preshielding by the grid and cassette.

In this area of the table, we can ignore the contribution from the chest tube location due to distance and oblique barrier penetration; hence, the *Rad Room (floor or other barriers)* workload distribution will be utilized for the secondary calculation. Assuming a secondary distance of 2 m with leakage radiation plus side-scattered radiation (2 m not indicated in Figure 5.2), the unshielded secondary air kerma, using Table 4.7 and Equation 4.4, is:

$$K_{\text{sec}}(0) = \frac{2.3 \times 10^{-2} \text{ mGy patient}^{-1} \times 125 \text{ patients week}^{-1}}{(2 \text{ m})^2} = 0.72 \text{ mGy week}^{-1}.$$

The total transmitted air kerma by a barrier of thickness x_{barrier} is then:

$$K_{\text{tot}}(x_{\text{barrier}}) = [0.72 \text{ mGy week}^{-1} \times B_{\text{sec}}(x_{\text{barrier}})] \\ + [7.5 \text{ mGy week}^{-1} \times B_{\text{p}}(x_{\text{barrier}} + x_{\text{pre}})],$$

where $B_{\text{sec}}(x_{\text{barrier}})$ is the secondary and $B_{\text{p}}(x_{\text{barrier}} + x_{\text{pre}})$ the primary transmission. A closed solution for x_{barrier} is not possible, even assuming the same transmission data applies to both primary and secondary source components due to x_{pre} . Trial solutions may be made by iteration to find the final thickness x_{barrier} required to reduce K to $P/T = 0.02 \text{ mGy week}^{-1}$.

An example of the procedure would be as follows for the case of $P/T = 0.02 \text{ mGy week}^{-1}$. Since the primary beam alone with preshielding required 0.6 mm lead, the qualified expert would probably recommend 0.79 mm lead (standard 1/32 inch thickness). One approach is to determine if 0.8 mm lead is in fact adequate. Using $x_{\text{barrier}} = 0.8 \text{ mm}$ lead and $x_{\text{pre}} = 0.3 \text{ mm}$ lead, the total transmitted air kerma is:

$$K_{\text{tot}}(0.8 \text{ mm}) = (0.72 \text{ mGy week}^{-1} \times 5 \times 10^{-3}) + (7.5 \text{ mGy week}^{-1} \times 1.4 \times 10^{-3}) \\ = 0.014 \text{ mGy week}^{-1}.$$

where transmission data has been obtained using Figure C.2 and Figure B.2 for the *Rad Room (floor or other barriers)* distribution. Therefore, 0.8 mm lead is adequate, resulting in $<0.02 \text{ mGy week}^{-1}$. A more complete calculation utilizing all sources (but ignoring oblique incidence from the chest tube location) yields $x_{\text{barrier}} = 0.78 \text{ mm}$ lead.

The methodology of Section 4.2.4 also may be used to determine this barrier thickness. Using the distance $d = 2.8 \text{ m}$ from the cross-table lateral primary tube location to the occupied area:

$$\frac{NT}{Pd^2} = 797 \text{ mGy}^{-1} \text{ m}^{-2}.$$

Accounting for image-receptor shielding from Figure 4.5b, a lead barrier 0.83 mm thick is required. If the image-receptor shielding is ignored, a lead barrier of 1.03 mm (Figure 4.5a) would be required.

5.3.6 Control Wall in the Radiographic Room

The area behind the control wall shown in Figure 5.2 is a controlled area and, as discussed in Section 2.2.1, this control booth region *should* be considered a secondary barrier. Assuming a secondary distance of 1.8 m and the leakage plus 90 degree side-scatter value for the *Rad Room (all barriers)* workload distribution from Table 4.7, the unshielded secondary air kerma for 125 patients per week, from Equation 4.4, is:

$$K_{\text{sec}}(0) = \frac{3.4 \times 10^{-2} \text{ mGy patient}^{-1} \times 125 \text{ patients week}^{-1}}{(1.8 \text{ m})^2} = 1.3 \text{ mGy week}^{-1}.$$

To reduce this to the shielding design goal for a controlled area ($P = 0.1 \text{ mGy week}^{-1}$), a secondary barrier transmission of:

$$B_{\text{sec}}(x_{\text{barrier}}) = \frac{0.1 \text{ mGy week}^{-1}}{1.3 \text{ mGy week}^{-1}} = 7.7 \times 10^{-2}.$$

is required. Use of Figure C.2 for the *Rad Room (all barriers)* workload distribution indicates that the required lead barrier thickness for the control booth is approximately 0.27 mm. This can be verified by using the methodology of Section 4.2.4. Here, $NT/Pd^2 = 386$ also requires a lead barrier thickness of 0.27 mm from the “Secondary Wall” curve in Figure 4.5c. The qualified expert can specify a conservatively safe thickness of 1/32 inch sheet lead for this control wall and a similar equivalent lead thickness of lead glass for the view window in this wall.

There is often an additional factor that will influence the design of a control booth to a greater extent than protection of the operator. As discussed in Section 5.3.4, Suleiman *et al.* (1995) have shown that fogging of x-ray film in a cassette will occur if it is exposed to $0.5 \mu\text{Gy}$ ($5 \times 10^{-4} \text{ mGy}$) or more. Many facilities typically store loaded cassettes behind the control barrier in radiographic and R&F rooms. Assuming a recycling time of 1 d, during which time an average of 25 patients will be radiographed (1/5 the weekly workload), the control wall shielding required is calculated as follows:

$$K_{\text{sec}}(0) = \frac{3.4 \times 10^{-2} \text{ mGy patient}^{-1} \times 25 \text{ patients}}{(1.8 \text{ m})^2} = 0.26 \text{ mGy}.$$

To reduce this to $5 \times 10^{-4} \text{ mGy}$ requires a secondary barrier transmission of:

$$B_{\text{sec}}(x_{\text{barrier}}) = \frac{5 \times 10^{-4} \text{ mGy}}{0.26 \text{ mGy}} = 1.9 \times 10^{-3}.$$

Use of Figure C.2 for the *Rad Room (all barriers)* workload distribution indicates that the required lead barrier thickness for the control booth is 1.3 mm. This cannot be verified by using the methodology of Section 4.2.4 since the NT/Pd^2 value (15,432) (here P/T is 5×10^{-4} mGy for 1 d) is well outside the range of values in the graph in Figure 4.5c.

Unless specific information indicating that loaded cassettes will not be stored behind the control booth, the 0.5 μGy limitation for loaded cassettes per storage period *should* be assumed. As discussed by Sutton and Williams (2000), shielding of computed radiography cassettes behind the control wall should not introduce any more restrictive limitations than film/screen storage because fewer cassettes are typically used and therefore use of these is more frequent.

5.4 Radiographic and Fluoroscopic Room

Use of a radiographic and fluoroscopic (R&F) room may vary widely from one facility to another. A larger facility may have a room dedicated to patients requiring fluoroscopy, whereas a smaller facility may use the room for fluoroscopic cases as well as for cases requiring only radiographic exposures. The latter is probably more common than the former. That is, after several fluoroscopic cases in the morning, the room may revert to a purely radiographic room for the remainder of the day. Most fluoroscopic cases will also involve the overhead radiographic tube for taking additional films covering a larger field-of-view than available with spot-film images or for cross-table lateral films.

A R&F room can therefore represent a complex set of workloads and workload distributions. A typical room used only for fluoroscopic cases would be used for about 20 patients per week (the average room usage from the clinical survey) with the workload in mA min week^{-1} being dominated by the fluoroscopy tube (about 13 $\text{mA min patient}^{-1}$ for the fluoroscopy tube and 1.5 $\text{mA min patient}^{-1}$ for the overhead tube). The secondary transmission curves for these two workload distributions indicate that the x-ray spectra are roughly equivalent and more penetrating than the x-ray spectra for the workload distribution for a purely radiographic room. This is reasonable since the use of contrast media will often require higher operating potentials.

In the following example, an under-table fluoroscopy tube will be assumed. The primary beam from the fluoroscopic tube is totally intercepted by the over-table image intensifier assembly

and attenuated to below scattered radiation levels. Thus, only secondary radiation from this tube (consisting of scattered radiation from the patient and x-ray tube leakage) needs to be considered, even for spot films. A conservatively safe assumption is that the secondary radiation produced by the fluoroscopy tube is not attenuated by the table, Bucky assembly, or any shielding built into the fluoroscopy system, such as lead drapes. The primary beam from the radiographic tube will be treated as in Section 5.3.

The calculational method is illustrated for the case of a R&F room used for 20 fluoroscopy and 60 radiographic-only cases per week. This is a conservatively heavy workload for a room of this type. The assumed room layout is shown in Figures 5.1 and 5.2. Note that this example is representative of a relatively large R&F room. The shielding requirements for smaller rooms will be correspondingly greater.

5.4.1 Secondary Barrier Calculation for the Floor in the Radiographic and Fluoroscopic Room

Assume that the occupied area beneath the R&F room is uncontrolled ($P = 0.02 \text{ mGy week}^{-1}$) and fully occupied ($T = 1$).

Consider the area at the position of the woman in Figure 5.1 outside of the primary beam of the over-table tube. The leakage and scattered radiation distances, d_L and d_S , are 2.4 and 3 m for the fluoroscopic tube and 4.1 and 3 m for the radiographic tube, respectively (2.4 and 3 m not indicated on Figure 5.1).

As before, the difference in the chest tube and overhead tube locations with respect to the floor is ignored and all secondary radiation from the radiographic tube is assumed to be due to the over-table location.

For the fluoroscopic tube, the *Fluoroscopy Tube (R&F room)* workload distribution in Table 4.7 is used. Assuming leakage and forward/backscattered radiations and evaluating the contribution of each separately, the unshielded secondary air kerma from the fluoroscopic tube, from Equation 4.4, is:

$$K_{\text{sec}}(0) = \left[\frac{1.2 \times 10^{-2} \text{ mGy patient}^{-1}}{(2.4 \text{ m})^2} + \frac{4.4 \times 10^{-1} \text{ mGy patient}^{-1}}{(3 \text{ m})^2} \right] \\ \times 20 \text{ patients week}^{-1} = 1 \text{ mGy week}^{-1}.$$

The over-table radiographic tube is used to image the 20 fluoroscopic patients, as well as the 60 radiographic-only patients each

week. Assuming leakage radiation and 90 degree side-scattered radiation, and evaluating the contribution of each separately, for the fluoroscopic patients and radiographic-only patients separately, the unshielded secondary air kerma from the radiographic tube, from Equation 4.4, is:

$$\begin{aligned}
 K_{\text{sec}}(0) &= \left[\frac{5.3 \times 10^{-4} \text{ mGy patient}^{-1}}{(4.1 \text{ m})^2} + \frac{3.4 \times 10^{-2} \text{ mGy patient}^{-1}}{(3 \text{ m})^2} \right] \\
 &\quad \times 60 \text{ patients week}^{-1} \\
 &\quad + \left[\frac{9.4 \times 10^{-4} \text{ mGy patient}^{-1}}{(4.1 \text{ m})^2} + \frac{2.8 \times 10^{-2} \text{ mGy patient}^{-1}}{(3 \text{ m})^2} \right] \\
 &\quad \times 20 \text{ patients week}^{-1}.
 \end{aligned}$$

The first term represents the radiographic-only contribution using the *Rad Room (all barriers)* workload distribution in Table 4.7. The second term represents the use of the radiographic tube in conjunction with the fluoroscopic cases, using the *Rad Tube (R&F room)* workload distribution in Table 4.7. The total secondary air kerma to the floor beneath the room due to the over-table radiographic tube is thus:

$$K_{\text{sec}}(0) = 0.23 + 0.063 = 0.29 \text{ mGy week}^{-1}.$$

Adding the previously determined fluoroscopic air kerma, the total unshielded air kerma from both the fluoroscopic and radiographic tubes is:

$$K_{\text{sec}}(0) = 1 \text{ mGy week}^{-1} + 0.29 \text{ mGy week}^{-1} = 1.3 \text{ mGy week}^{-1}.$$

The barrier transmission required to reduce this to the shielding design goal for uncontrolled areas is:

$$B_{\text{sec}}(x_{\text{barrier}}) = \frac{0.02 \text{ mGy week}^{-1}}{1.3 \text{ mGy week}^{-1}} = 1.5 \times 10^{-2}.$$

Assuming the workload distribution with the greater penetrating power of the two relevant secondary radiation transmission curves in Figure C.3 [*Rad Tube (R&F room)*], the required concrete thickness for the floor is 62 mm.

The methodology of Section 4.2.4 may be used to quickly determine this barrier thickness. Let $d = 3$ m from the patient to the occupied area. For a total of $N = 60 + 20 = 80$ patients per week, $NT/Pd^2 = 444 \text{ mGy}^{-1} \text{ m}^{-2}$. From Figure 4.8c, the required concrete barrier thickness in the floor for off-table secondary radiation is 65 mm. This is in good agreement with the thickness of 62 mm calculated above.

5.4.2 Primary Barrier Calculation for the Floor in the Radiographic and Fluoroscopic Room

The area beneath the fluoroscopic table (position of the man in Figure 5.1) is irradiated by both the primary radiographic beam (attenuated by the grid, cassette and radiographic table before striking the floor) and the secondary radiation from the fluoroscopic tube. The contribution from secondary radiation generated when the overhead tube is not directed down at the table will be ignored. This is reasonable because the table bucky assembly and table will intercept a significant fraction of the secondary radiation.

The unshielded secondary air kerma from the fluoroscopic tube for 20 patients per week is 1 mGy week^{-1} , as in the previous example.

Primary radiation is generated by the radiographic tube for 60 patients per week following the *Rad Room (floor or other barriers)* workload distribution, and for 20 patients per week following the *Rad Tube (R&F room)* workload distribution. From Equation 4.3 with $U = 1$ and Table 4.5, the unshielded primary air kerma is:

$$K_p(0) [\text{Rad Room (floor or other barriers)}] = \frac{5.2 \text{ mGy patient}^{-1} \times 1 \times 60 \text{ patients week}^{-1}}{(4.1 \text{ m})^2} = 18.6 \text{ mGy week}^{-1}$$

$$K_p(0) [\text{Rad Tube (R\&F room)}] = \frac{5.9 \text{ mGy patient}^{-1} \times 1 \times 20 \text{ patients week}^{-1}}{(4.1 \text{ m})^2} = 7 \text{ mGy week}^{-1}$$

The first calculation accounts for the 60 radiographic patients and the second calculation accounts for the 20 patients undergoing radiography as part of the fluoroscopic examination. The primary beam components will be attenuated by both the floor thickness x_{barrier} and the preshielding thickness x_{pre} due to the image receptor and table hardware. Since the primary transmissions of the two workload distributions are different [*i.e.*, the kVp workload distri-

bution for the *Rad Tube (R&F room)* is more penetrating than that of the *Rad Room (floor or other barriers)*, the two calculations are made separately.

The floor thickness x_{barrier} needs to be determined so that the shielding design goal divided by the occupancy factor (P/T) from all contributions in the occupied space is $<0.02 \text{ mGy week}^{-1}$. That is:

$$\begin{aligned} 0.02 \text{ mGy week}^{-1} &= [1 \text{ mGy week}^{-1} \times B_{\text{sec}}(x_{\text{barrier}})] \\ &+ [18.6 \text{ mGy week}^{-1} \times B_{\text{P,Rad}}(x_{\text{barrier}} + x_{\text{pre}})] \\ &+ [7 \text{ mGy week}^{-1} \times B_{\text{P,R\&F}}(x_{\text{barrier}} + x_{\text{pre}})] \end{aligned}$$

where $x_{\text{pre}} = 72 \text{ mm}$ concrete from Table 4.6. Here $B_{\text{sec}}(x_{\text{barrier}})$ is the secondary radiation transmission for the fluoroscopic tube and $B_{\text{P,Rad}}(x_{\text{barrier}} + x_{\text{pre}})$ and $B_{\text{P,R\&F}}(x_{\text{barrier}} + x_{\text{pre}})$ are the transmission of the primary beam from the over-table radiographic tube for the *Rad Room (floor or other barriers)* and the *Rad Tube (R&F room)* workload distributions, respectively.

Even if the same workload distribution for all three components were assumed, a closed solution for x_{barrier} is not possible due to x_{pre} . Trial solutions for x_{barrier} need to be made. The required secondary radiation barrier thickness for the floor was previously found to be 62 mm (due primarily to scattered and leakage radiations from the fluoroscopic tube which also contributes to the air kerma beneath the table in this example). Therefore, the floor clearly needs to be thicker than 62 mm. Arbitrarily choosing a trial solution of $x_{\text{barrier}} = 72 \text{ mm}$, then, from Figure C.3, $B_{\text{sec}}(72 \text{ mm}) = 1.1 \times 10^{-2}$, and, from Figure B.3, the primary radiation transmissions $B_{\text{P,Rad}}(72 \text{ mm} + 72 \text{ mm}) = 1 \times 10^{-4}$ and $B_{\text{P,R\&F}}(72 \text{ mm} + 72 \text{ mm}) = 5 \times 10^{-4}$. The total air kerma transmitted by the assumed barrier thickness is:

$$\begin{aligned} K_{\text{tot}}(72 \text{ mm}) &= (1 \text{ mGy week}^{-1} \times 1.1 \times 10^{-2}) + (18.6 \text{ mGy week}^{-1} \times 1 \times 10^{-4}) \\ &+ (7 \text{ mGy week}^{-1} \times 5 \times 10^{-4}) \\ &= (0.011 + 0.002 + 0.004) \text{ mGy week}^{-1} \\ &= 0.017 \text{ mGy week}^{-1} \end{aligned}$$

Thus, the total air kerma transmitted through 72 mm concrete is below $0.02 \text{ mGy week}^{-1}$, as required. A more complete calculation shows that a minimum of 69 mm of concrete is required for the floor in order to obtain $0.02 \text{ mGy week}^{-1}$.

The methodology of Section 4.2.4 may be used to quickly determine this barrier thickness. Let $d = 4.1$ m from the over-table radiographic tube location to the occupied area. For $N = 60 + 20 = 80$ patients week⁻¹, $NT/Pd^2 = 238$ mGy⁻¹ m⁻². From Figure 4.8b, the required concrete barrier thickness is 70 mm. This is in excellent agreement with the thickness calculated above.

5.5 Mammography

Mammography is radiographic imaging of the breast. Specially-designed equipment, consisting of an x-ray tube with a molybdenum, rhodium or tungsten anode and molybdenum, rhodium or aluminum filtration, is used. These units have a C-arm configuration with the image-receptor size not exceeding 24×30 cm. The source-to-image-receptor distance typically does not exceed 0.8 m. Mammography procedures are generally performed at operating potentials not exceeding 35 kVp and the vast majority of mammographic images are created at <30 kVp (Simpkin, 1996b). Mammographic x-ray beams have HVLs <1 cm in tissue (NCRP, 1986). Typically, four images are acquired for each patient. These consist usually of two craniocaudal views with the mammographic beam pointed toward the floor, and two mediolateral oblique views with the beam directed at an angle toward opposite adjacent walls.

The mammographic image-receptor assembly is required by regulation to serve as a primary beam stop to the vast majority of the primary radiation (FDA, 2003b). A small strip (<1.2 cm) of primary radiation up to two percent of the SID in width is allowed to miss the image receptor along the chest-wall edge of the beam. However, most of this radiation is attenuated to insignificant levels by the patients. Hence, only secondary radiation need be considered for mammography rooms.

Differences in the shielding requirements between mammography beams generated by molybdenum, rhodium or tungsten anodes with molybdenum, rhodium and aluminum filtration at operating potentials not exceeding 35 kVp are not significant.

Simpkin (1996b) has measured the secondary radiation as a function of scattered radiation angle and primary beam intensity. These results have been combined with the *Mammography Room* workload distribution from Table 4.2 to yield the unshielded secondary air kerma near a mammographic unit. For a patient procedure consisting of one craniocaudal and one mediolateral oblique image of each breast, the air kerma per patient 1 m from the isocenter of the unit was estimated conservatively high. This was calculated assuming the workload distribution in Table 4.2 for a

24 × 30 cm image receptor at 60 cm SID, with the isocenter midway between the x-ray tube focal spot and image receptor and maximum forward-scattered radiation (*i.e.*, at 25 degrees).

In the direction of the craniocaudal view (usually the floor), the air kerma per patient at 1 m was found to be 2.6×10^{-2} mGy, while that directed toward an adjacent wall is 3.1×10^{-2} mGy. A maximum air kerma of 3.6×10^{-2} mGy patient⁻¹ at 1 m is seen in the direction opposite to the craniocaudal orientation (usually toward the ceiling). The air kerma near mammographic units is thus close to an isotropic distribution. It would, therefore, be conservatively safe to assume that the unshielded air kerma at 1 m from mammographic units is:

$$K_{\text{sec}}^1 = 3.6 \times 10^{-2} \text{ mGy patient}^{-1}.$$

This differs somewhat from the entries in Table 4.7 since here the 1 m distance is measured from the isocenter of the mammography unit for all four views, and not from the x-ray tube and patient as in Table 4.7.

Although this value (3.6×10^{-2} mGy patient⁻¹) is based on 100 mAs (milliampere-seconds) per exposure, it assumes that most of the workload is at 30 to 35 kVp using a molybdenum target and molybdenum filter (Table 4.2). Modern mammographic units typically employ *kVp* values which are lower than this, and therefore employ higher mAs values. However, in the case of larger breasts where the *kVp* must be raised, a rhodium filter is typically inserted automatically to reduce the entrance exposure and consequently the resulting scattered radiation. Therefore, 3.6×10^{-2} mGy patient⁻¹ is still conservatively high. It corresponds to the case of maximum scattered radiation (with a scatter-to-primary radiation ratio of 5.4×10^{-4} for a scattering angle of 160 degrees), with an entrance air kerma of 17 mGy. This latter value is typical of the exposure required by the automatic exposure control for a relatively large (6 cm) breast thickness.

Example: Consider a mammography suite imaging 150 patients per week. The isocenter of the mammographic equipment is located 2.1 m from an uncontrolled, fully occupied ($P/T = 0.02$ mGy week⁻¹) area on the other side of an adjacent wall. The total unshielded weekly air kerma in this area, from Equation 4.4, is:

$$K_{\text{sec}}(0) = \frac{K_{\text{sec}}^1 N}{d_{\text{sec}}^2} = \frac{3.6 \times 10^{-2} \text{ mGy patient}^{-1} \times 150 \text{ patients week}^{-1}}{(2.1 \text{ m})^2} \\ = 1.2 \text{ mGy week}^{-1}.$$

In order to act as an adequate shielding barrier, the wall requires transmission not greater than:

$$B_{\text{sec}}(x_{\text{barrier}}) = \frac{P/T}{K_{\text{sec}}(0)} = \frac{0.02 \text{ mGy week}^{-1}}{1.2 \text{ mGy week}^{-1}} = 1.7 \times 10^{-2}.$$

which, from Figure C.4, is satisfied by 9.8 mm of gypsum wallboard.

Now, suppose the opposite wall contains a door to an uncontrolled corridor 2.1 m from the mammographic unit. An occupancy factor of 1/8 for a corridor door (given in Table 4.1) is assumed. Thus, $P/T = 0.02 \text{ mGy week}^{-1}/(1/8) = 0.16 \text{ mGy week}^{-1}$. The required transmission for the corridor door is:

$$B_{\text{sec}}(x_{\text{barrier}}) = \frac{0.16 \text{ mGy week}^{-1}}{1.2 \text{ mGy week}^{-1}} = 1.3 \times 10^{-1}.$$

which, from Figure C.7, is satisfied by 41 mm of solid wood. From Table 2.1, a solid-core wooden door (43 mm thick) would provide an adequate barrier. It is important to note that there is substantial conservatism (on the safe side) inherent in these two calculations. This is because the effective dose (in millisievert) in the mammography energy range to an individual moving about the uncontrolled area (*i.e.*, rotational exposure is assumed) is <20 percent of the incident air kerma (in milligray) due to the low penetrating power of the photons (ICRP, 1996; ICRU, 1998b).

As illustrated in this example, it is concluded that:

1. standard gypsum wallboard construction is usually adequate to shield the walls of a typical mammography facility, but the required thickness of the gypsum wallboard *should* be determined by the qualified expert as illustrated above;
2. additional shielding is usually not required in the wall or door behind the patient due to self-shielding by the body of the patient;

3. solid-core wooden doors (*e.g.*, American Woodwork Institute Type PC5, 43 mm thick doors) leading to corridors outside a mammographic room may provide adequate shielding. However, standard wooden doors may not be sufficient if the shielded area has significant occupancy. The adequacy of a standard thickness, solid-core wooden door *should* be demonstrated by the qualified expert;
4. standard concrete construction provides adequate barriers above and below mammographic facilities; and
5. lead-lined walls and doors are usually not required.

5.6 Computed Tomography

Modern computed tomography (CT) scanners consist of a rotating x-ray tube that generates a fan beam of x rays collimated to a nominal width of T_b (centimeters) along the axis of rotation. X-ray tube potentials of 120 to 140 kVp are typically employed and produce relatively high levels of scattered radiation that may require significant shielding. During CT operation in a helical scan mode, the patient is positioned on the CT table and continuously moved along the axis of rotation with velocity v . The radiation beam traces out a helix on the surface of a cylindrical phantom (helical or spiral scanner) and the x-ray tube rotation time (τ) is on the order of 1 s or less per 360 degrees. If the patient translation per gantry rotation $b = v\tau$ is greater than the nominal beam width T_b , the pitch (p) of the sequence ($p = b/T_b$) is greater than unity. In a “multi-slice” scanner, multiple detector rings along the axis of rotation may be used to collect several image sections per rotation that are thinner than the nominal collimated beam width (McCollough and Zink, 1999). For a single-slice acquisition scanner, the nominal beam width (reconstructed slice thickness) is usually variable over the range of 1 to 10 mm. For a “multi-slice” or “multiple-row detector”¹¹ scanner, the nominal beam width may be 40 mm or more and include n reconstructed slices. In each case, the total beam width determines the amount of scattered radiation per rotation.

The standard CT dosimetry phantoms (FDA, 2003d; Shope *et al.*, 1981) are assumed in this Report to reasonably represent a head and body, insofar as scattered radiation from a patient is concerned. These phantoms are 16 and 32 cm diameter acrylic cylinders for the head and body, respectively, with a length of approximately 15 cm.

¹¹In the literature, the reader may find multiple-row detector scanners identified as “MDCT” scanners.

Only secondary radiation (primarily scattered radiation and some leakage radiation) is considered since the primary beam is normally attenuated to well below the scattered radiation levels by the detectors and gantry hardware. For an axial or helical scan series consisting of N_R total rotations, the scattered air kerma at 1 m for a given phantom diameter is expected to be proportional to the line integral of the accumulated absorbed dose $D(z)$ along the axial direction z [*i.e.*, the dose-line integral (DLI)] (Dixon, 2003).

$$K_S^1 = \kappa \int_{-\infty}^{\infty} D(z) dz = \kappa DLI = \kappa N_R \int_{-\infty}^{\infty} f(z) dz \quad (5.1)$$

where κ is a proportionality constant and $f(z)$ is the dose profile resulting from a single axial rotation (with no phantom motion).

The computed tomography dose index ($CTDI_{100}$) measured with a single axial rotation using a 10 cm (100 mm) long ionization chamber (in units of air kerma) is defined (EC, 1999; IEC, 2002) as:

$$CTDI_{100} = \frac{1}{T_b} \int_{-5 \text{ cm}}^{5 \text{ cm}} f(z) dz \quad (5.2)$$

where T_b is the nominal beam width on the axis of rotation (for multi-slice scanners where n slices of width T_n are acquired per rotation, $T_b = nT_n$).

Thus, the scattered air kerma per patient at 1 m can be approximated by:

$$K_S^1 = \kappa DLI \approx \kappa N_R T_b CTDI_{100}, \quad (5.3)$$

where the DLI is analogous to dose-length product (DLP), but refers only to a single axis within the phantom, either the central axis or at the phantom periphery.

This can be expressed in terms of the length of patient scanned $L = N_R b$, where b is the scan interval for axial scans and $b = v\tau$ is the table advance per rotation for helical scans.

$$K_S^1 = \kappa \frac{L}{p} CTDI_{100}, \quad (5.4)$$

This methodology assumes an isotropic scattered radiation distribution, rather than the “hourglass” shaped isodose distributions typically given by the CT manufacturers. In the plane of x-ray tube rotation, scattered radiation is greatly reduced due to attenuation by the gantry hardware. In fact, scattered radiation levels do not reach maximum value until an angle of about 30 degrees with this plane is reached. This will allow use of an obliquity factor ($\cos\theta$) reduction in the shielding thickness for the floor and ceiling if

necessary, as discussed by Sutton and Williams (2000). The angle θ is the angle of incidence with the barrier.

In this Report, the peripheral phantom axis 1 cm below the surface is used as the reference axis. The scatter fraction per centimeter (κ) for the peripheral axis of the FDA (2003d) head and body phantoms has been measured and the following values were obtained:¹²

$$\kappa_{\text{head}} = 9 \times 10^{-5} \text{ cm}^{-1} \quad (5.5a)$$

$$\kappa_{\text{body}} = 3 \times 10^{-4} \text{ cm}^{-1}. \quad (5.5b)$$

Since these measured κ values include a small tube leakage radiation component, the air kerma calculated from them is denoted as K_{sec} . Values of the $CTDI_{100}$ for various CT scanner models have been tabulated and are available on the Imaging Performance Assessment of Computed Tomography Scanners web site (ImPACT, 2004). These values scale to other kVp values approximately as the square of the kVp (e.g., the $CTDI_{100}$ at 140 kVp can be obtained by multiplying the 120 kVp value by 1.4, if it is determined that the facility commonly uses 140 kVp). The ImPACT (2004) web site contains the actual measured values of $CTDI_{100}$ per 100 mAs at various kVp settings and is periodically updated as new scanner models become available. One must be careful, however, to use the peripheral axis value of $CTDI_{100}$ with the scatter fractions provided in this Report.

If ${}_nCTDI_{100}$ is defined as the $CTDI_{100}$ normalized per mAs, then:

$$K_{\text{sec}}^1 = \kappa N_R T_b \text{ mAs } {}_nCTDI_{100} = \kappa \frac{L}{p} \text{ mAs } {}_nCTDI_{100}. \quad (5.6)$$

$CTDI_{100}$ values are also obtainable from the manufacturers, however, care should be taken not to confuse $CTDI_{100}$ with $CTDI_{\text{FDA}}$ (FDA, 2003d), which is also provided (often as an unsubscripted $CTDI$) (McNitt-Gray, 2002).

Example: As a simplified illustrative example using $CTDI_{100}$, consider a multi-slice scanner. The site anticipates a workload of 100 patients per 40 h week, of which 60 patients receive one body scan and 40 patients receive one head scan. The average technique is 120 kVp, with $T_b = 2$ cm (e.g., four 5 mm slices are acquired per rotation),

¹²Shearer, D.R. (2000). Personal communication (Rhode Island Hospital, Providence, Rhode Island).

with an average scan length L for a head scan of 20 cm at 300 mAs and a pitch of unity, and $L = 50$ cm for a body scan at 250 mAs using a pitch of 1.35. The ${}_nCTDI_{100}$ values are 0.223 and 0.138 mGy mAs⁻¹ for a head and body scan, respectively.

Thus, from Equation 5.6, the secondary air-kerma values per patient at 1 m for one head and one body scan, respectively, are:

$$\begin{aligned} K_{\text{sec}}^1 (\text{head}) &= (9 \times 10^{-5} \text{ cm}^{-1})(20 \text{ cm})(300 \text{ mAs})(0.223 \text{ mGy mAs}^{-1}) \\ &= 0.12 \text{ mGy patient}^{-1} \\ K_{\text{sec}}^1 (\text{body}) &= (3 \times 10^{-4} \text{ cm}^{-1}) \left(\frac{50 \text{ cm}}{1.35} \right) (250 \text{ mAs})(0.138 \text{ mGy mAs}^{-1}) \\ &= 0.38 \text{ mGy patient}^{-1}. \end{aligned}$$

Therefore, for a barrier bounding an uncontrolled, fully-occupied area at 3 m distance from the isocenter, the unshielded weekly secondary air kerma for the total of 100 patients would be:

$$K_{\text{sec}} = \left(\frac{1 \text{ m}}{3 \text{ m}} \right)^2 [40 (0.12) + 60 (0.38)] = 3.1 \text{ mGy week}^{-1}.$$

The required barrier transmission is:

$$B = \frac{0.02 \text{ mGy week}^{-1}}{3.1 \text{ mGy week}^{-1}} = 6.5 \times 10^{-3}.$$

The required barrier thickness from the CT scanner attenuation curves (Figure A.2 in Appendix A) is:

$$x_{\text{barrier}} = 1.3 \text{ mm lead}.$$

Thus a 1/16 inch standard lead thickness (1.59 mm) is adequate for this barrier under the conditions stated above. It is important to note that the shielding provided by the standard concrete floor and ceiling in a modern multi-slice scanner room may not be adequate (Langer and Gray, 1998).

5.6.1 Dose-Length Product Method

Computed tomography is currently undergoing rapid and significant change. Several CT manufacturers now display *DLP*

values or $CTDI_{vol}$ for a given scan series on the scanner monitor (Nagel, 2002) where:

$$DLP = CTDI_{vol} L \quad (5.7)$$

and

$$CTDI_{vol} = \frac{1/3 CTDI_{100, center} + 2/3 CTDI_{100, periphery}}{p} \quad (5.8)$$

and the length of patient scanned L is given by:

$$L = N_R b \quad (5.9)$$

It may become more convenient to use the DLP to establish the relevant techniques and to compute shielding requirements directly from DLP rather than $CTDI_{100}$. This Section will therefore review how shielding can be determined using DLP .

Assuming that the $CTDI_{100}$ for the peripheral axis in the body phantom is twice that of the central axis, and that the $CTDI_{100}$ for the two axes are equal in the head phantom, the relevant equations become:

$$K_{sec}^1 (\text{head}) = \kappa_{head} DLP \quad (5.10a)$$

$$K_{sec}^1 (\text{body}) = 1.2 \kappa_{body} DLP \quad (5.10b)$$

Regarding clinical usage, first note that most CT facilities utilize multiple “procedure codes” on many patients. For example, the abdomen and pelvis are commonly scanned together, but are counted as two “procedures” for billing purposes by the administrator. As in the case of radiography previously discussed in Section 4.1.4, the number of procedures will exceed the number of patients. However, for the special case of CT, it is reasonable and informative to use the number of procedures as a total weekly workload value rather than the number of patients. Table 5.2 illustrates some currently suggested default DLP values per “procedure.” The DLP values (in Table 5.2) result from reference values for DLP by EC (1999) and estimates of average values of $CTDI_{vol}$ in the United States derived from the American College of Radiology accreditation program.¹³ These values are subject to change as the clinical applications of CT technology continue to be developed.

¹³McCollough, C.H. (2004). Personal communication (Mayo Clinic, Rochester, Minnesota).

TABLE 5.2—Currently suggested default *DLP* values per procedure.^{a,b,c}
For use as a guide in planning shielding in cases where facility-specific
DLP values are not available.

Procedure	$CTDI_{vol}$ (mGy)	Scan Length (<i>L</i>) (cm)	<i>DLP</i> (mGy cm)
Head	60	20	1,200
Chest	15	35	525
Abdomen	25	25	625
Pelvis	25	20	500
Body average (chest, abdomen or pelvis)			550

^aThese values result from reference values for *DLP* by EC (1999) and estimates of average values of $CTDI_{vol}$ in the United States derived from the American College of Radiology accreditation program. As indicated in Section 5.6.1, these values are subject to change in the future.

^bThe number of procedures will likely exceed the number of individual patients examined (Section 4.1.4).

^cFor the subset of procedures that is performed with and without contrast, the *DLP* value in Table 5.2 must be doubled.

Secondly, there is an important caveat that the qualified expert needs to be aware of. A single procedure code is commonly used in the case where the examination (*e.g.*, abdomen, pelvis, chest, or head) is done both with and without contrast media. This essentially represents two scans of the same anatomic area, and thereby doubles the *DLP*. The facility administrator should therefore be asked to provide not only the total number of head and body procedures, but also the number (or fraction) of those procedures that are performed both with and without contrast media. The default *DLP* values in Table 5.2 must be doubled for this subset of procedures. In the absence of such information, it is suggested that the qualified expert assume that 40 percent of all procedures are repeated with contrast,¹³ resulting in an overall average *DLP* of 1.4 times the default *DLP* value shown in Table 5.2.

Example: Assume that 150 “body” procedures and 30 head procedures are performed weekly at a site, with

¹³McCullough, C.H. (2004). Personal communication (Mayo Clinic, Rochester, Minnesota).

40 percent of both head and body procedures having a pre- and post-contrast scan. The area to be protected is a fully-occupied real estate office behind an adjoining wall 3 m from the CT unit isocenter.

The “body average” and head *DLP* values from Table 5.2 of 550 and 1,200 mGy cm, respectively, are therefore to be increased by a factor of 1.4, to 770 and 1,680 mGy cm, as illustrated below. From Equation 5.10, the secondary air-kerma values at 1 m, adjusted for the procedures with pre- and post-contrast scans, are:

$$\begin{aligned} K_{\text{sec}}^1 (\text{body}) &= (1.2) (3 \times 10^{-4} \text{ cm}^{-1})(550 \text{ mGy cm} \times 1.4) \\ &= 0.28 \text{ mGy procedure}^{-1} \end{aligned}$$

$$\begin{aligned} K_{\text{sec}}^1 (\text{head}) &= (9 \times 10^{-5} \text{ cm}^{-1})(1,200 \text{ mGy cm} \times 1.4) \\ &= 0.15 \text{ mGy procedure}^{-1} \end{aligned}$$

For a workload consisting of the procedures listed in this example, the unshielded weekly secondary air kerma at 3 m distance from the isocenter would be:

$$\begin{aligned} K_{\text{sec}} &= \left(\frac{1 \text{ m}}{3 \text{ m}} \right)^2 [(150 \text{ procedures week}^{-1}) (0.28 \text{ mGy procedure}^{-1}) \\ &+ (30 \text{ procedures week}^{-1})(0.15 \text{ mGy procedure}^{-1})] = 5.2 \text{ mGy week}^{-1} \end{aligned}$$

with a required barrier transmission for a public (uncontrolled) area with $T = 1$ of:

$$B = \frac{0.02 \text{ mGy week}^{-1}}{5.2 \text{ mGy week}^{-1}} = 3.9 \times 10^{-3}.$$

and a corresponding barrier thickness from the CT scanner attenuation curves (Figure A.2 in Appendix A) of:

$$x_{\text{barrier}} = 1.5 \text{ mm lead.}$$

5.6.2 The Isodose Map Method

As an alternative method of calculation (Sutton and Williams, 2000), scattered radiation isodose contour maps provided by the manufacturer may be utilized. Care must be taken, however, to note the total slice width (T_b) and the technique (*i.e.*, *kVp* and *mAs*) utilized for the measurement of these distributions in order that they may be normalized to the appropriate clinical techniques. Also, the appropriateness of the phantom utilized should be evaluated.

5.6.3 Cautionary Notes

Several notes of caution regarding CT shielding design are in order here. Attempting to utilize a workload expressed in mA min week⁻¹ is not recommended. This is because a multi-slice scanner acquiring a 2 cm total slice width per rotation will require only one-half of the mA min week⁻¹ of a single-slice scanner acquiring a 1 cm width, but the scattered air kerma will be approximately the same.

Finally, regardless of the methodology ultimately used, it is essential that the qualified expert stay abreast of the rapidly changing developments in CT imaging and consider future advances to ensure that the required degree of radiation protection is achieved both in the short and the long term.

5.7 Bone Mineral Density Units (Dual Energy X-Ray Absorption Scanners)

Bone densitometry x-ray units utilize dual energy x-ray absorption. The spine and hip (femur) or both hips of the patient are typically scanned either with a narrowly collimated x-ray fan beam or a pencil beam which emanates from under the table and which is intercepted by an over-table detector or detector array. Some units are also capable of making lateral exposures. In either case, only scattered radiation from the patient is relevant for shielding purposes. The x-ray tube is switched between a high- and a low- kVp during the scan (*e.g.*, 140 and 70 kVp), and the beam is heavily filtered.

A fan beam scanner may generate scattered air-kerma rates of up to 0.04 mGy h⁻¹ at 1 m, whereas the scattered radiation rates for pencil beam scanners are around 2×10^{-3} mGy h⁻¹. However, scan acquisition times are generally shorter for fan beam units. The manufacturers generally provide scattered radiation rates at 1 m and typical scan times for various examinations (*e.g.*, hip, spine, whole body, and forearm).

Example: The manufacturer of a fan beam unit states that the scattered air-kerma rate at 1 m is <0.04 mGy h⁻¹ and that a spine and hip scan can each be done in 15 s. If a facility is planning to examine 60 patients per week with both a spine and hip scan being performed on each patient (0.5 h scan time per week), then the air kerma at 1 m is <0.02 mGy week⁻¹. This is below the shielding

design goal for a fully-occupied uncontrolled area where $P = 0.02 \text{ mGy week}^{-1}$. Therefore, no structural shielding is needed even for the smallest rooms in this example. Patel *et al.* (1996) have reported some scattered radiation data from several scanners.

The operator is typically not protected by any barrier, and distance from the unit is used for protection. Hence, it is recommended that the operator be positioned as far away from the table as practicable.

In most cases, no structural shielding is required for the typical workloads encountered (<50 patients per week). However the following caveats *should* be noted:

1. The manufacturer may state only the minimum scan time required for the examination. In practice, the facility may choose longer scan times in order to acquire more accurate data. Thus, it could be possible to exceed the shielding design goal for a fully-occupied uncontrolled area at 1 m distance. Additionally, many facilities routinely perform spine scans and bilateral hip scans on every patient (and other parts of the skeletal system may be scanned as well). It is therefore important to have accurate workload data.
2. There are no data currently available for attenuation of these heavily-filtered beams by building or shielding materials. A conservatively safe approach would be to use the asymptotic HVL at high attenuation for the highest kVp utilized by the unit. In most cases, however, the required protection may be achieved by repositioning the table in the room so that it is closest to a partially occupied area such as a corridor, or by using a larger room for the unit.
3. Scattered radiation levels from patients may be lower than those obtained using the smaller phantoms provided with the scanner. This is the result of greater self-absorption in the patient.

The adequacy of shielding is best determined with an on-site radiation survey during a patient procedure or with the use of a suitable phantom. This allows the direct determination of the average scan time per patient and the measurement of actual scattered radiation rates in adjacent areas.

5.8 Shielding Design Report

The report of the qualified expert *shall* be sent to the architect (or builder if no architect is involved) and the owner (or administrator) of the facility. Additionally, state regulations may require submission of a report (“plan review”) to a state agency.

The report noted above *shall* list the assumptions made in the design concerning workload and occupancy factors for the adjacent areas (including areas above and below the x-ray room), as well as other pertinent assumptions that may restrict the present or future use of the x-ray room. The summary of the report sent to the architect and owner should be presented in clear, nontechnical terms. For example, the workload should be given as the number of patients per week (the usual units mA min week⁻¹ would not be readily understood by nonphysicists). Partial occupancy should be stated in understandable terms such as fraction of a normal workday or work week. Assumptions concerning existing shielding that will be utilized as part of the design such as floor and ceiling slab construction or exterior masonry wall construction *shall* be listed.

The required shielding thickness *should* be specified in terms of standard, available construction materials. For example, calculated lead thicknesses should be rounded up to the nearest commercial thickness available. Specifying the required barrier as 0.45 mm lead would be confusing to the architect or contractor. As shown in Figure 2.3, the shielding thickness required for a computed thickness of 0.45 mm lead would be reported as 1/32 inch lead, which is the minimum thickness (0.79 mm) available commercially that exceeds the computed thickness. In certain cases it is useful to provide shielding requirements for alternate standard materials that could be used in lieu of lead. These may include concrete, concrete block, brick, plate glass, steel, wood, or other materials.

For wall shielding, the required height of the shielding above the finished floor *shall* be specified. The normal specification is 2.1 m (approximately seven feet), but the requirement may be higher for a darkroom wall (2.5 m, approximately eight feet, three inches) (Section 5.3.4). In situations where additional shielding is required in the ceiling, the lead in the wall should, in most cases, be abutted to the ceiling lead.

6. Radiation Protection Surveys

6.1 Introduction

The radiation protection survey is an on-site evaluation of the x-ray facility performed by or under the direction of a qualified expert. It is typically performed after the facility is completed, although some components may be conducted prior to the completion of construction. The purpose of the survey is to ensure the protection of employees and members of the public. The survey consists of two basic elements:

1. an inspection to verify that barriers are properly placed, contiguous and free of voids or defects; and
2. an evaluation of shielding adequacy to verify that barriers adequately attenuate exposures in nearby occupied areas to the relevant shielding design goal divided by the appropriate occupancy factor (P/T).

Approval or disapproval by the qualified expert *shall* be based on compliance with the recommendations of this Report and any other applicable federal, state and local regulations. If the survey reveals deficiencies, additional shielding or modifications of equipment and procedures are required. If supplementary shielding is required, a survey *shall* be performed after its installation. In addition, a survey *shall* also be made after any change that might significantly reduce the level of radiation protection.

6.2 Inspection for Voids

The shielding of the radiation room *shall* be constructed such that the protection is not impaired by voids or openings in protective barriers. Corrections made after the room is completed can be expensive and disruptive. Therefore, the designer and contractor *should* consult with the qualified expert to ensure that voids or openings will be eliminated from the completed facility. See Section 2 for a description of construction materials and principles

of shielding design for medical x-ray imaging facilities. Typical problems include the following:

- lead-lined dry wall panels that normally contain lead to a height of 2.1 m may be installed upside down and result in a significant gap in the shielding near the floor;
- the wall lead may not be properly lapped into door frames or view window frames, leaving gaps in the shielding integrity (wall lead should be properly lapped as shown in Figure 2.4);
- the integrity of the joints between lead sheets may be inadequate because the recommended overlap of 1 cm or more of lead is not present; and
- properly installed shielding may later be impaired by large gaps or voids due to the installation of electrical outlets, junction boxes, plumbing, air conditioning ducts, etc. Such voids *shall* be backed with compensatory shielding to ensure that the required degree of protection is maintained.

Voids in the barriers of the completed facility *should* be located by the use of a suitable x- or gamma-ray source and a sensitive radiation detector such as a Geiger-Mueller (GM) tube, scintillation detector or another radiation detection instrument with a fast response. The use of an audible indicator with a meter will save time in finding areas of unexpectedly high transmission. X-ray film may also be used to find defects. Searching for voids is difficult using a radiographic source since exposure time is limited to a few seconds. Alternatively, the fluoroscopic source in an R&F room or a portable C-arm fluoroscopic unit that allows continuous operation at low mA can be used with a scattering phantom. A radionuclide source may also be used, however, regulatory or licensing issues related to this specific use for these sources may have to be addressed. If a radionuclide is to be used, a low-energy gamma-ray source such as ^{99m}Tc is desirable. If the facility has a nuclear medicine department, the surveyor may be able to obtain a sample of ^{99m}Tc to test the shielding. If not, a radioactive materials license that specifically permits the transport of the radionuclide to the facility and its subsequent disposal may be required.

A visual inspection during the construction phase may be adequate to ensure that barriers are free of voids. The visual inspection should also be used to ensure that the lead shielding for utility boxes or other voids has been appropriately installed. However, since additional voids in shielding may occur after the visual inspection during the remaining construction, an inspection for

voids in the completed facility *should* also be performed. The response of a detector in the presence of a small void will depend on the relative size of the void to that of the detector and the transmission factor of the lead for the source utilized.

6.3 Evaluation of Shielding Adequacy

A key element in assessing the level of radiation protection afforded by the barriers in a facility is a qualified expert's on-site evaluation of the shielding adequacy. The evaluation *should* determine if an adequate thickness of lead or other material has been installed by estimating the number of patients that may undergo x-ray procedures without exceeding the shielding design goal of the adjacent areas. This portion of the survey usually will involve direct measurement of the x-ray transmission provided by each barrier. In some instances however, it may be possible to verify the amount and type of shielding by visual inspection. If the qualified expert is readily available (such as an in-house physicist) during the construction phase, then it is possible to carry out many aspects of the shielding evaluation without radiation measurements.

This evaluation is important because assumptions made by the designer concerning room usage (workload, workload *kVp* distribution, use factors) and occupancy factors for nearby rooms may have been incorrect. The shielding designer's information concerning room usage may have come directly from the architect or the x-ray equipment vendor with little or no interaction with the management of the facility. The surveyor *should* perform an independent evaluation of assumed workload and other design parameters based upon on-site observations and interviews with the users of the x-ray facility.

6.3.1 *Visual Inspection to Determine the Presence and Thickness of Radiation Barriers Before the Structure Has Been Completed*

It may be possible, with one or more mid-construction visits, to observe that the appropriate type and thickness of shielding is being properly installed (not upside down, for example). One can readily determine the thickness of lead glued to gypsum wallboard or in a door, if it is visible. However, some doors have edges covered with strips of wood or plastic that obscure the shielding material. The degree of overlap between lead sheets or between lead and other barrier materials can be observed. The thickness of concrete

in a slab floor may often be determined from concrete form design or from core-drilled holes made for electrical conduits or plumbing. However, as illustrated in Figure 2.4, the thickness determined by a single hole may not be representative of the minimal floor thickness of the room. Additionally, the thickness of concrete alone is not adequate to determine shielding capabilities since density can vary.

If it is not practical to obtain all necessary information by direct observation, it may be possible to acquire statements certifying the lead equivalence of materials and concrete density utilized, or to obtain material samples. For example, the supplier usually certifies the lead equivalence of leaded glass or acrylic. Samples of concrete for density determination can be poured from the same mix and at the same time as a shielding barrier.

The on-site evaluation may also uncover problems with the room layout due to changes that occurred after the design phase. Typical problems encountered may include:

- view windows that limit the ability of the radiographer to visualize the patient both on the table and against the wall bucky while remaining in the protected control area;
- unattenuated primary or singly-scattered radiation paths into the control area or to areas outside of the room from the x-ray table or wall bucky;
- changes in equipment layout, room configuration or adjacent areas that will affect the shield design, and warning signs; or
- warning lights required by regulation that may be missing or improperly installed.

6.3.2 *Transmission Measurements to Determine the Presence and Thickness of Radiation Barriers*

If the thickness and composition of radiation barriers cannot be determined by visual inspection, it is necessary to determine the barrier transmission factor. This may be measured by using the primary x-ray beam of a fixed or portable x-ray unit and an appropriate survey instrument (Appendix D). Alternatively, scattered radiation from a radiographic or fluoroscopic x-ray unit also may be used when it is impossible or inconvenient to use the primary beam. A water equivalent phantom at least 20 cm thick with a convex upper surface wide enough to accommodate a 1,000 cm² field

may be used to generate the necessary scattered radiation levels. If the phantom is rectangular, the beam should come relatively near the edges so that the scattered radiation is not attenuated significantly by the phantom itself.

For measuring primary beam transmission through the x-ray table and vertical cassette holder, the beam should be collimated to a large cassette placed in the image receptor. The total primary beam shielding thickness is the sum of the structural barrier thickness (x_{barrier}) and the effective thickness of the image-receptor hardware in the beam including the cassette (x_{pre}) (Section 4.2.2).

The measurement point on the exit side of a barrier *should* normally be at the nearest likely approach of the sensitive organs of a person to the barrier. As discussed in Section 4.1.2, this is 0.3 m for a wall; for floor penetration, this distance is 1.7 m above the floor below the x-ray room; and for ceilings, a distance of 0.5 m above the floor of the room above the x-ray room. In some special cases, such as a nursing station or outdoor sidewalk, the distance to the nearest routinely occupied area may be considerably greater.

6.3.3 Determination of the Adequacy of Radiation Barriers

As discussed in Section 4, an x-ray unit will typically be operated with a characteristic kVp workload distribution. In order to measure the actual radiation levels beyond the various barriers resulting from the actual workload, it would be necessary to place sensitive, integrating dosimeters (*e.g.*, optically-stimulated luminescent dosimeters) on the outside of all barriers for a period of time. This is not practical when results are required in a short time frame. It is also not practical to simulate a standard workload distribution with the full range of exposures for each kVp interval because of the large number of measurements that would be required. The following method is suggested as an acceptable alternative for estimating the average weekly air kerma beyond a given x-ray barrier. The method relies on a determination of the equivalent barrier thickness (x_{barrier}) either by direct inspection, or inferred from a measurement of the transmission factor [$B(x_{\text{barrier}})$] using an x-ray beam or a suitable radionuclide source. Once the equivalent barrier thickness (x_{barrier}) has been determined, the methods of Section 4 can be used to determine N , the number of patients per week that can be examined without exceeding the appropriate weekly value of P/T , by solving Equations 4.7 (for a primary barrier) or Equation 4.9 (for a secondary barrier). N can also be calculated using the value for NT/Pd^2 and Figures 4.5 through 4.8. Examples are illustrated below.

6.3.3.1 Primary Barrier: Chest-Bucky Wall. The surveyor collimates the beam to the largest field on the chest bucky and puts a matching cassette in the holder. A measurement behind the bucky on the other side of the wall at 100 kVp and 60 mAs yields an air kerma of 1×10^{-3} mGy. Assume that the area is uncontrolled with $P = 0.02$ mGy week $^{-1}$ and $T = 1/2$. The distance from the x-ray tube to the point at which the 100 kVp and 60 mAs measurement of 1×10^{-3} mGy was made is determined to be 2.5 m. The unattenuated primary beam output of the x-ray tube is measured at 100 kVp and 60 mAs at 1 m and is determined to be 5 mGy. The unattenuated primary air kerma at 2.5 m is $K_p(0) = (5 \text{ mGy}) (1 \text{ m}/2.5 \text{ m})^2 = 0.80$ mGy.

Therefore, the barrier transmission factor at 100 kVp is:

$$B(x_{\text{barrier}} + x_{\text{pre}}) = \frac{1 \times 10^{-3} \text{ mGy}}{0.8 \text{ mGy}} = 1.25 \times 10^{-3}.$$

Using data for transmission of x rays produced at 100 kVp through lead (values of α , β and γ from Table A.1) and Equation A.3 yields:

$$\begin{aligned} x_{\text{barrier}} + x_{\text{pre}} &= (2.5 \times 0.7557)^{-1} \ln \left\{ \left[(1.25 \times 10^{-3})^{-0.7557} + \frac{15.28}{2.5} \right] \left(1 + \frac{15.28}{2.5} \right)^{-1} \right\} \\ &= 1.66 \text{ mm}. \end{aligned}$$

From Figure 4.5a for the standard radiographic room for the chest-bucky-wall primary barrier, a thickness equivalent to 1.66 mm of lead would permit an NT/Pd^2 value of 480 mGy $^{-1}$ m $^{-2}$. Substituting values for T (1/2), P (0.02 mGy week $^{-1}$), and d (2.5 m), it is concluded that a total of 120 patients per week may be examined (based on the primary beam air kerma beyond this barrier) without exceeding the shielding design goal.

The problem could also be solved using the transmission factor data for the *Rad Room (chest bucky)* workload distribution (Figure B.2 or Table B.1). The transmission factor for 1.66 mm of lead for this distribution is 9.3×10^{-4} . Note that this is somewhat smaller than the value determined above for the 100 kVp “test” exposure. The unshielded primary air kerma per patient at 1 m is 2.3 mGy (Table 4.5), thus the air kerma per patient to an occupant of the room adjacent to the chest bucky is:

$$\frac{K_p}{N} = \frac{2.3 \text{ mGy patient}^{-1}}{(2.5)^2} (9.3 \times 10^{-4}) = 3.4 \times 10^{-4} \text{ mGy patient}^{-1}.$$

If the area is uncontrolled with $P = 0.02 \text{ mGy week}^{-1}$ and $T = 1/2$, then $P/T = 0.04 \text{ mGy week}^{-1}$ and N is given by:

$$N = \frac{0.04 \text{ mGy week}^{-1}}{3.4 \times 10^{-4} \text{ mGy patient}^{-1}} = 120 \text{ patients week}^{-1},$$

thereby, confirming the above result obtained using the standard radiographic room curves.

6.3.3.2 Secondary Barrier: Chest-Bucky Wall, Area Beyond Chest Bucky. The surveyor aims the primary beam at a portion of the chest-bucky wall not behind the chest bucky and measures $1.1 \times 10^{-2} \text{ mGy}$ at 100 kVp and 60 mAs at 2.5 m. Again $P = 0.02 \text{ mGy week}^{-1}$ and $T = 1/2$. The barrier transmission at 100 kVp is given by:

$$B(x_{\text{barrier}}) = \frac{1.1 \times 10^{-2} \text{ mGy}}{0.8 \text{ mGy}} = 1.4 \times 10^{-2}.$$

Solving Equation A.3 using the parameters from Table A.1 at 100 kVp yields $x_{\text{barrier}} = 0.8 \text{ mm}$ lead equivalence.

Using the curve for “chest-bucky secondary wall” from Figure 4.5c, the value of NT/Pd^2 that corresponds to 0.8 mm of lead is $1,050 \text{ mGy}^{-1} \text{ m}^{-2}$. Assuming that the source to secondary barrier distance is 2.5 m, the allowable patient workload for this barrier is about 260 patients per week. Since this value is much larger than the value of 120 patients per week found in the previous example, the shielding requirements for the primary radiation will prevail in determining the allowable patient workload for this wall.

6.3.3.3 Cross-Table Wall. Assume that a visual inspection indicated that 0.8 mm (1/32 inch) lead is present in this barrier. The surveyor assumes that a cassette with a lead equivalence of 0.3 mm lead (Table 4.6) also acts as a primary barrier for each cross-table lateral exposure. Thus, the total lead equivalence of this primary barrier is 1.1 mm. Assume the wall bounds a physician’s office at a distance of 2 m with an occupancy factor of 1/4 such that $P/T = 0.08 \text{ mGy week}^{-1}$. From the “cross-table lateral wall” curve in Figure 4.5a, NT/Pd^2 is 1,000. Therefore, $N = 320$ patients per week.

6.3.3.4 Secondary Barrier at Which it is Impossible to Aim Primary Beam. Assume that this barrier is the control booth wall with a distance of 2.5 m from the table center to the operator. A scattering phantom is placed on the x-ray table. The radiographic beam is

directed vertically downward at 100 cm SID with a 1,000 cm² field size. A measurement behind the wall at a distance of 2.5 m from the scatterer at 100 kVp and 240 mAs (4 mA min) yields 0.2 μGy. A measurement of the unattenuated radiation (that includes scattered and leakage radiations) is made at 1 m for an exposure of 100 kVp and 240 mAs. This yields an air kerma of 92 μGy. Thus, the barrier transmission factor for secondary radiation is:

$$B(x_{\text{barrier}}) = \frac{0.2 \mu\text{Gy}}{92 \mu\text{Gy}} \left(\frac{2.5 \text{ m}}{1 \text{ m}} \right)^2 = 1.4 \times 10^{-2}.$$

which yields $x_{\text{barrier}} = 0.9$ mm lead equivalence. Note that to determine the value for x_{barrier} , values for α , β and γ to be used with Equation A.3 were taken from Table C.1 for 100 kVp.

Using the suggested shielding design goal for a controlled area, $P = 0.1$ mGy week⁻¹ with $T = 1$, and Figure 4.5c, the “secondary wall” curve indicates that $NT/Pd^2 > 3,000$ mGy⁻¹ m⁻², hence $N > 1,900$ patients per week.

6.3.3.5 Floor. Assume a fully-occupied uncontrolled area ($P/T = 0.02$ mGy week⁻¹) with a primary beam distance of 4 m to a person below. A visual inspection indicated that the floor contains 70 mm of standard-weight concrete. The surveyor can assume that the table and associated hardware (Section 4.1.6.2 and Table 4.6) provides preshielding having an equivalent thickness of 72 mm, which also acts as a primary barrier for each over-table exposure. Thus, the total concrete equivalent thickness for this primary barrier is 142 mm. Use of Figure 4.6a for the “floor” curve reveals that $NT/Pd^2 = 2,000$ mGy⁻¹ m⁻². This value yields $N = 640$ patients per week. The adequacy of the floor may also be determined by radiation measurements following the same procedures used for the chest-bucky wall in Sections 6.3.3.1 and 6.3.3.2. This is accomplished by making the exposure in the primary beam area with the preshielding of the x-ray table and bucky assembly in the beam.

6.3.3.6 Summary. In this example, all barriers will be adequate for a facility with an average of 120 patients per week. This patient load is typical for an average radiographic room.

6.3.4 Computed Tomography Scanner Survey

For a computed tomography (CT) scanner, the kVp is typically not varied significantly. Hence, absolute secondary air-kerma measurements outside the room may be made using a suitable patient

phantom and a typical scan technique [kVp , mA, scan time, and total slice thickness (T_b)]. An anthropomorphic phantom is desirable to realistically simulate scattered radiation and its attenuation from a body or head; however, a cylindrical water phantom may be utilized since these are usually available on-site as quality control phantoms. A 16 cm and a 32 cm diameter phantom are appropriate for head and body scans, respectively. The length of the phantom should be sufficient to adequately represent scattered radiation attenuation in a head or a body.

Consider a single-slice CT scanner as an example. The scattered air kerma for a single 10 mm slice (one rotation) at a technique of 120 kVp and 300 mAs yields an air kerma of 0.01 μGy behind a barrier bounding an uncontrolled, fully-occupied area ($P/T = 0.02 \text{ mGy week}^{-1}$). This would allow 2,000 slices per week. The facility uses an average of 40 slices per patient, hence, approximately 50 patients per week could be examined.

For a multi-slice scanner, a typical technique might be a total nominal beam width (T_b) of 20 mm per rotation. In this case, the 40 cm length of patient scanned in the example above could be acquired in only 20 rotations. The scattered air kerma per rotation would be approximately twice the value of 0.01 μGy in the previous example. Thus, the number of patients per week would be approximately the same. Note, however, that the workload expressed in mA min week^{-1} would be half that for the single-slice scanner.

6.4 Survey Report

Reports are often needed by several entities. The contractor and the institution (operator) are the most common recipients. If barriers are found to be unsatisfactory, others such as the architects or the qualified expert who specified the shielding plan, are likely to be interested in the results, but from different perspectives. For example, the institution will usually look for a safety statement while contractors usually want verification that the facility was built according to plan. The surveyor should be aware of these different perspectives and the final report or reports should meet the needs of all involved parties. Note, however, that in some cases different groups may utilize different surveyors.

In some cases, the most significant part of the report is the conclusion. This is best expressed in terms of agreement or disagreement with anticipated use. This conclusion should be expressed in clear terms readily understood by all parties concerned. This *shall* include the number of patients per week that can be examined without exceeding the relevant weekly shielding design goals (and,

therefore, without exceeding the applicable annual effective dose values recommended in this Report for controlled and uncontrolled areas).

In addition to the results, all significant assumptions and caveats need to be included. Measurements and measurement techniques, computational methods and parameters, and survey equipment used may also be included. The significant steps followed by the surveyor should be clearly presented, in such a way that another qualified surveyor is able to reproduce parts or all of the steps and achieve a similar conclusion. If problems are found, the surveyor may wish to include abatement suggestions (Section 6.5). There may be possible future modifications that would change the conclusion of the report. These include changes of equipment, changes of occupancies or use of environs, or changes in standards or regulations. Although all possible changes cannot be foreseen, the surveyor should attempt to indicate either the limitations of the conclusions or those conditions that would warrant a reanalysis or resurvey of the facility.

The survey report and any subsequent recommendations for remediation which are to be acted upon *shall* be in writing and *shall* be signed by a qualified expert.

6.5 Problem Abatement

A problem arises when the result of a survey indicates that the shielding is inadequate. A variety of strategies can be used for the abatement of these problems. The choice of these is likely to be guided partly by responsibility for the problem and the cost of the solution.

Minor problems can be solved relatively easily. Examples include minor installation errors involving the x-ray unit or shielding hardware. These are usually fixed quickly at no added expense, provided the installation or contractor personnel are still available.

Often a problem may be eliminated by more complete information than was originally supplied to the surveyor. As an example, a waiting room without an attendant will have a lower occupancy than one with an attendant. As another example, a corridor may be restricted to x-ray personnel whereas the surveyor had assumed an unrestricted use.

Sometimes uncertain situations can be satisfactorily clarified with further studies. These may include maintenance of a log or the use of radiation monitoring devices for places or personnel. Care needs to be applied in interpretation of these detailed studies. For

example, a new facility may not be utilized at the anticipated patient load for several months.

More serious problems occur when it is determined that a significant amount of additional shielding or other expensive solutions are required. In these cases, it is sometimes necessary to determine who is at fault. Sometimes this can be easily determined as in the case in which the construction team fails to build according to the design specifications. More often, the fault is simply due to mid-construction design changes that appeared unimportant and as a result a qualified expert was not consulted. A difficult situation can also arise when recommendations or regulations change while the project is maturing.

If most of the work is to be performed by a contractor, the facility management usually does not budget contingency funds for shielding corrections. Nevertheless, the facility management will ultimately be responsible for correcting an adverse survey finding. Occasionally, a zealous engineer or administrator is eager to apply maximum pressure for an expensive and complete correction of any fault, but more commonly an inexpensive, but effective correction which does not impair the utility of a facility is possible.

A major problem that is not amenable to the corrections described in this Section, will require a solution that is more or less disagreeable to one or more of the entities concerned. These solutions are of two types. One is to apply additional shielding; the other is restriction on use. Shielding is easily increased in most instances by overlaying additional shielding rather than replacing the original installation. This can only be done when the additional shielding thickness is acceptable. For a wall, adding another layer of gypsum wallboard backed with lead is considerably quicker and less expensive than replacing the wall. However, the wall will become approximately 2 cm thicker. Note that an overlay can be applied to whichever side of the wall is most convenient, since the removal of cabinetry and other fixtures may be involved.

Corrective restrictions can take several forms. Restricting the direction of the primary beam, limiting the number of procedures, or perhaps even changing the procedures assigned to the room can modify the exterior air kerma. On the other side of the barrier, it may be possible to change the occupancy either by changing the use (*e.g.*, an office is turned into a store room) or by controlling access (*e.g.*, a space open to the public is turned into a controlled area). In a few cases, it may also be possible to modify the position of the closest approach on the protected side of a barrier. For example, installing lateral files or equivalent cabinets to a wall will add at least half a meter to the distance of closest approach.

Restrictions that require continuing administrative oversight are less desirable than truly permanent solutions. Temporary solutions are appropriate for limited periods while permanent solutions are put in place. For example, if the wall between an x-ray room and a laboratory is found to be inadequate it would be appropriate to restrict the work areas in the laboratory for a few months while more shielding is being obtained for the wall. Such restrictions, unless ensured by permanent equipment placement, *shall not* be considered a suitable long-term solution.

6.6 Documentation

The following documentation *shall* be maintained on a permanent basis by the owner of the facility:

- shielding design data including assumptions and specifications
- construction or as-built documents showing amounts of shielding material installed
- survey reports
- information regarding remedies, if any were required
- subsequent reevaluations of the room shielding requirements as a result of changes in room use, number of patients, and equipment replacement

A permanent placard *should* be mounted in the room specifying the amount and type of shielding in each of the walls.

Appendix A

Transmission Data

The broad-beam transmission [$B(x)$] of x rays through a shielding barrier of thickness x of a given material m is defined as the ratio of the air kerma from a broad x-ray beam to an occupied area when shielded [$K(x)$] to that in an unshielded condition [$K(0)$]:

$$B(x,m) = \frac{K(x)}{K(0)}. \quad (\text{A.1})$$

Transmission will depend on the energies of the x rays and the thickness and material of the shielding barrier. The attenuation of scattered radiation is assumed to be equal to that of the primary beam, since to first approximation the energy spectrum of scattered photons is the same as that for primary photons generated at <150 kVp. The transmission of leakage radiation is assumed to have a simple exponential relationship with the thickness of the barrier material since penetration through the tube housing will have removed all but the highest energy x rays generated in the tube. For tube operation at a given potential, the leakage radiation penetration power will exceed that of the primary and scattered radiations. The HVL of the leakage radiation is assumed to be the same as the HVL of the primary beam determined at great depth.

The measurements of Archer *et al.* (1994) will be assumed to represent primary broad-beam transmission of x rays from modern medical x-ray imaging equipment operated between 50 and 150 kVp in lead, steel, plate glass, gypsum wallboard, lead acrylic, and wooden barriers. For concrete, the primary transmission data of Legare *et al.* (1978), will be employed. In the mammographic range (25 to 35 kVp), transmission values of Simpkin (1987a) will be used.

The transmission B of broad x-ray beams through a variety of shielding materials in medical x-ray imaging applications has been found to be well described by a mathematical model published by

Archer *et al.* (1983). This model has the form where x is the thickness of shielding material and α , β and γ are the fitting parameters:

$$B = \left[\left(1 + \frac{\beta}{\alpha} \right) e^{\alpha \gamma x} - \frac{\beta}{\alpha} \right]^{\frac{1}{\gamma}}, \quad (\text{A.2})$$

Equation A.2 may be solved for the thickness x as a function of transmission B :

$$x = \frac{1}{\alpha \gamma} \ln \left(\frac{B^{-\gamma} + \frac{\beta}{\alpha}}{1 + \frac{\beta}{\alpha}} \right). \quad (\text{A.3})$$

This form proves useful in describing both primary and secondary transmission curves for x rays generated at both single operating potentials and those generated following clinical workload distributions.

Fitting parameters to Equations A.2 and A.3 are available at 5 kVp intervals in Table A.1 for primary three-phase aluminum-filtered tungsten-anode radiographic and molybdenum-anode and filtered mammographic x-ray beams (Simpkin, 1995). These were obtained by interpolation of published transmission data (Archer *et al.*, 1994; Legare *et al.*, 1978; Simpkin, 1987a).

For large values of x , known as the high-attenuation condition, the transmission curves tend toward an exponential that decreases with constant HVL. The HVL (symbol $x_{1/2}$) at high attenuation are shown in Figure A.1 for a variety of shielding materials (lead, concrete, gypsum wallboard, plate glass, and wood). This value may be extracted from the transmission fitting parameters. From the asymptotic form of Equation A.2, $x_{1/2} = (\ln 2)/\alpha$. For a kVp distribution of workloads, a conservatively safe assumption is that the HVL at high attenuation is the same as that for the highest operating potential in the distribution.

The transmission of secondary radiations from CT units will exceed that of radiographic units operated at the same potential since additional primary beam filtering is employed in these devices. Figures A.2 and A.3 show the transmission of 120 and 140 kVp secondary radiation from CT scanners in lead and concrete, respectively (refit from data of Simpkin, 1991). These data are the results of Monte Carlo calculations of the transmission of medical x-ray imaging beams hardened to simulate spectra typical of CT scanners.

TABLE A.1—Fits of transmission for broad primary x-ray beams (for lead, concrete, gypsum wallboard, steel, plate glass, and wood) to Equation A.2 (thickness x is input in millimeters).

kV_p^b	Lead			Concrete ^a			Gypsum Wallboard		
	α (mm ⁻¹)	β (mm ⁻¹)	γ	α (mm ⁻¹)	β (mm ⁻¹)	γ	α (mm ⁻¹)	β (mm ⁻¹)	γ
25	4.952×10^1	1.940×10^2	3.037×10^{-1}	3.904×10^{-1}	1.645	2.757×10^{-1}	1.576×10^{-1}	7.175×10^{-1}	3.048×10^{-1}
30	3.880×10^1	1.780×10^2	3.473×10^{-1}	3.173×10^{-1}	1.698	3.593×10^{-1}	1.208×10^{-1}	7.043×10^{-1}	3.613×10^{-1}
35	2.955×10^1	1.647×10^2	3.948×10^{-1}	2.528×10^{-1}	1.807	4.648×10^{-1}	8.878×10^{-2}	6.988×10^{-1}	4.245×10^{-1}
40				1.297×10^{-1}	1.780×10^{-1}	2.189×10^{-1}			
45				1.095×10^{-1}	1.741×10^{-1}	2.269×10^{-1}			
50	8.801	2.728×10^1	2.957×10^{-1}	9.032×10^{-2}	1.712×10^{-1}	2.324×10^{-1}	3.883×10^{-2}	8.730×10^{-2}	5.105×10^{-1}
55	7.839	2.592×10^1	3.499×10^{-1}	7.422×10^{-2}	1.697×10^{-1}	2.454×10^{-1}	3.419×10^{-2}	8.315×10^{-2}	5.606×10^{-1}
60	6.951	2.489×10^1	4.198×10^{-1}	6.251×10^{-2}	1.692×10^{-1}	2.733×10^{-1}	2.985×10^{-2}	7.961×10^{-2}	6.169×10^{-1}
65	6.130	2.409×10^1	5.019×10^{-1}	5.528×10^{-2}	1.696×10^{-1}	3.217×10^{-1}	2.609×10^{-2}	7.597×10^{-2}	6.756×10^{-1}
70	5.369	2.349×10^1	5.881×10^{-1}	5.087×10^{-2}	1.696×10^{-1}	3.847×10^{-1}	2.302×10^{-2}	7.163×10^{-2}	7.299×10^{-1}
75	4.666	2.269×10^1	6.618×10^{-1}	4.797×10^{-2}	1.663×10^{-1}	4.492×10^{-1}	2.066×10^{-2}	6.649×10^{-2}	7.750×10^{-1}
80	4.040	2.169×10^1	7.187×10^{-1}	4.583×10^{-2}	1.549×10^{-1}	4.926×10^{-1}	1.886×10^{-2}	6.093×10^{-2}	8.103×10^{-1}
85	3.504	2.037×10^1	7.550×10^{-1}	4.398×10^{-2}	1.348×10^{-1}	4.943×10^{-1}	1.746×10^{-2}	5.558×10^{-2}	8.392×10^{-1}

90	3.067	1.883×10^1	7.726×10^{-1}	4.228×10^{-2}	1.137×10^{-1}	4.690×10^{-1}	1.633×10^{-2}	5.039×10^{-2}	8.585×10^{-1}
95	2.731	1.707×10^1	7.714×10^{-1}	4.068×10^{-2}	9.705×10^{-2}	4.406×10^{-1}	1.543×10^{-2}	4.571×10^{-2}	8.763×10^{-1}
100	2.500	1.528×10^1	7.557×10^{-1}	3.925×10^{-2}	8.567×10^{-2}	4.273×10^{-1}	1.466×10^{-2}	4.171×10^{-2}	8.939×10^{-1}
105	2.364	1.341×10^1	7.239×10^{-1}	3.808×10^{-2}	7.862×10^{-2}	4.394×10^{-1}	1.397×10^{-2}	3.815×10^{-2}	9.080×10^{-1}
110	2.296	1.170×10^1	6.827×10^{-1}	3.715×10^{-2}	7.436×10^{-2}	4.752×10^{-1}	1.336×10^{-2}	3.521×10^{-2}	9.244×10^{-1}
115	2.265	1.021×10^1	6.363×10^{-1}	3.636×10^{-2}	7.201×10^{-2}	5.319×10^{-1}	1.283×10^{-2}	3.271×10^{-2}	9.423×10^{-1}
120	2.246	8.950	5.873×10^{-1}	3.566×10^{-2}	7.109×10^{-2}	6.073×10^{-1}	1.235×10^{-2}	3.047×10^{-2}	9.566×10^{-1}
125	2.219	7.923	5.386×10^{-1}	3.502×10^{-2}	7.113×10^{-2}	6.974×10^{-1}	1.192×10^{-2}	2.863×10^{-2}	9.684×10^{-1}
130	2.170	7.094	4.909×10^{-1}	3.445×10^{-2}	7.160×10^{-2}	7.969×10^{-1}	1.155×10^{-2}	2.702×10^{-2}	9.802×10^{-1}
135	2.102	6.450	4.469×10^{-1}	3.394×10^{-2}	7.263×10^{-2}	9.099×10^{-1}	1.122×10^{-2}	2.561×10^{-2}	9.901×10^{-1}
140	2.009	5.916	4.018×10^{-1}	3.345×10^{-2}	7.476×10^{-2}	1.047	1.088×10^{-2}	2.436×10^{-2}	9.964×10^{-1}
145	1.895	5.498	3.580×10^{-1}	3.296×10^{-2}	7.875×10^{-2}	1.224	1.056×10^{-2}	2.313×10^{-2}	9.987×10^{-1}
150	1.757	5.177	3.156×10^{-1}	3.243×10^{-2}	8.599×10^{-2}	1.467	1.030×10^{-2}	2.198×10^{-2}	1.013

kV_p^b	Steel			Plate Glass			Wood		
	α (mm ⁻¹)	β (mm ⁻¹)	γ	α (mm ⁻¹)	β (mm ⁻¹)	γ	α (mm ⁻¹)	β (mm ⁻¹)	γ
25	9.364	4.125×10^1	3.202×10^{-1}	3.804×10^{-1}	1.543	2.869×10^{-1}	2.230×10^{-2}	4.340×10^{-2}	1.937×10^{-1}
30	7.406	4.193×10^1	3.959×10^{-1}	3.061×10^{-1}	1.599	3.693×10^{-1}	2.166×10^{-2}	3.966×10^{-2}	2.843×10^{-1}
35	5.716	4.341×10^1	4.857×10^{-1}	2.396×10^{-1}	1.694	4.683×10^{-1}	1.901×10^{-2}	3.873×10^{-2}	3.732×10^{-1}
50	1.817	4.840	4.021×10^{-1}	9.721×10^{-2}	1.799×10^{-1}	4.912×10^{-1}	1.076×10^{-2}	1.862×10^{-3}	1.170
55	1.493	4.515	4.293×10^{-1}	8.552×10^{-2}	1.661×10^{-1}	5.112×10^{-1}	1.012×10^{-2}	1.404×10^{-3}	1.269
60	1.183	4.219	4.571×10^{-1}	7.452×10^{-2}	1.539×10^{-1}	5.304×10^{-1}	9.512×10^{-3}	9.672×10^{-4}	1.333
65	9.172×10^{-1}	3.982	4.922×10^{-1}	6.514×10^{-2}	1.443×10^{-1}	5.582×10^{-1}	8.990×10^{-3}	6.470×10^{-4}	1.353
70	7.149×10^{-1}	3.798	5.378×10^{-1}	5.791×10^{-2}	1.357×10^{-1}	5.967×10^{-1}	8.550×10^{-3}	5.390×10^{-4}	1.194
75	5.793×10^{-1}	3.629	5.908×10^{-1}	5.291×10^{-2}	1.280×10^{-1}	6.478×10^{-1}	8.203×10^{-3}	6.421×10^{-4}	1.062
80	4.921×10^{-1}	3.428	6.427×10^{-1}	4.955×10^{-2}	1.208×10^{-1}	7.097×10^{-1}	7.903×10^{-3}	8.640×10^{-4}	9.703×10^{-1}
85	4.355×10^{-1}	3.178	6.861×10^{-1}	4.721×10^{-2}	1.140×10^{-1}	7.786×10^{-1}	7.686×10^{-3}	1.056×10^{-3}	1.015
90	3.971×10^{-1}	2.913	7.204×10^{-1}	4.550×10^{-2}	1.077×10^{-1}	8.522×10^{-1}	7.511×10^{-3}	1.159×10^{-3}	1.081
95	3.681×10^{-1}	2.654	7.461×10^{-1}	4.410×10^{-2}	1.013×10^{-1}	9.222×10^{-1}	7.345×10^{-3}	1.133×10^{-3}	1.116
100	3.415×10^{-1}	2.420	7.645×10^{-1}	4.278×10^{-2}	9.466×10^{-2}	9.791×10^{-1}	7.230×10^{-3}	9.343×10^{-4}	1.309
105	3.135×10^{-1}	2.227	7.788×10^{-1}	4.143×10^{-2}	8.751×10^{-2}	1.014	7.050×10^{-3}	6.199×10^{-4}	1.365

110	2.849×10^{-1}	2.061	7.897×10^{-1}	4.008×10^{-2}	8.047×10^{-2}	1.030	6.921×10^{-3}	1.976×10^{-4}	3.309
115	2.579×10^{-1}	1.922	8.008×10^{-1}	3.878×10^{-2}	7.394×10^{-2}	1.033	6.864×10^{-3}	-3.908×10^{-4}	6.469×10^{-1}
120	2.336×10^{-1}	1.797	8.116×10^{-1}	3.758×10^{-2}	6.808×10^{-2}	1.031	6.726×10^{-3}	-8.308×10^{-4}	1.006
125	2.130×10^{-1}	1.677	8.217×10^{-1}	3.652×10^{-2}	6.304×10^{-2}	1.031	6.584×10^{-3}	-1.214×10^{-3}	1.192
130	1.969×10^{-1}	1.557	8.309×10^{-1}	3.561×10^{-2}	5.874×10^{-2}	1.037	6.472×10^{-3}	-1.539×10^{-3}	1.285
135	1.838×10^{-1}	1.440	8.391×10^{-1}	3.481×10^{-2}	5.519×10^{-2}	1.049	6.306×10^{-3}	-1.731×10^{-3}	1.465
140	1.724×10^{-1}	1.328	8.458×10^{-1}	3.407×10^{-2}	5.145×10^{-2}	1.057	6.191×10^{-3}	-1.849×10^{-3}	1.530
145	1.616×10^{-1}	1.225	8.519×10^{-1}	3.336×10^{-2}	4.795×10^{-2}	1.063	6.115×10^{-3}	-1.869×10^{-3}	1.498
150	1.501×10^{-1}	1.132	8.566×10^{-1}	3.266×10^{-2}	4.491×10^{-2}	1.073	6.020×10^{-3}	-1.752×10^{-3}	1.483

^aNote that fits for concrete assume standard-weight concrete.

^bThe 25 to 35 kVp data are for molybdenum-anode x-ray tubes. All other data are for tungsten-anode tubes. Data of Archer *et al.* (1994), Legare *et al.* (1978), and Simpkin (1987a), interpolated to 5 kVp intervals (Simpkin, 1995).

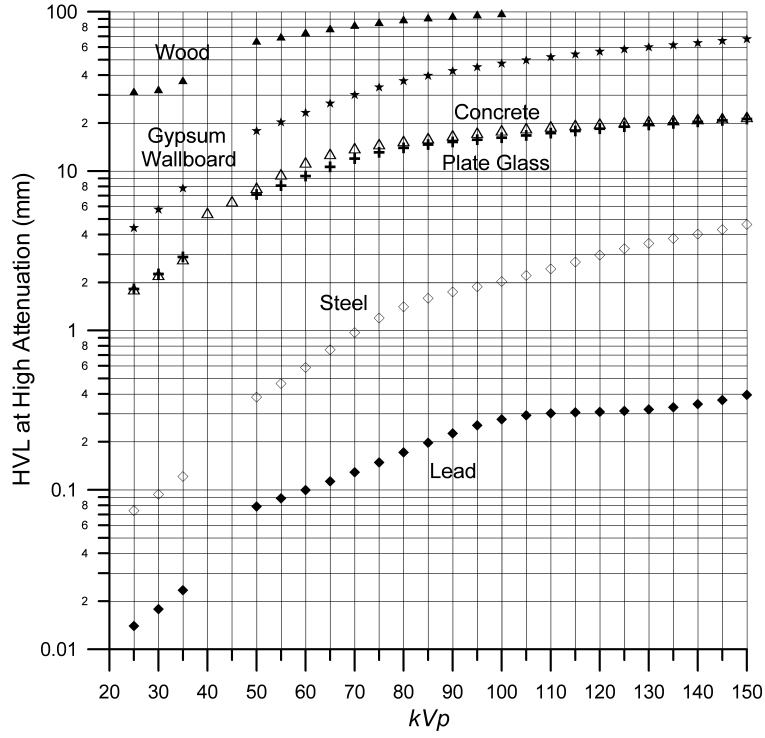

Fig. A.1. HVL at high attenuation (derived from fits of transmission in Table A.1).

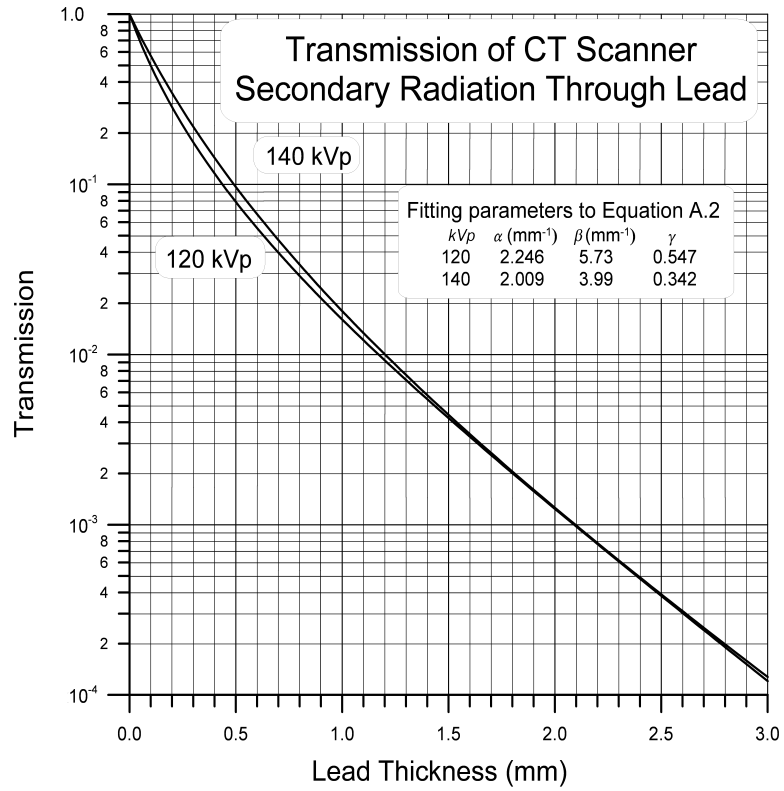

Fig. A.2. Transmission through lead of secondary radiation from CT scanners [data of Simpkin (1991) fitted to Equation A.2].

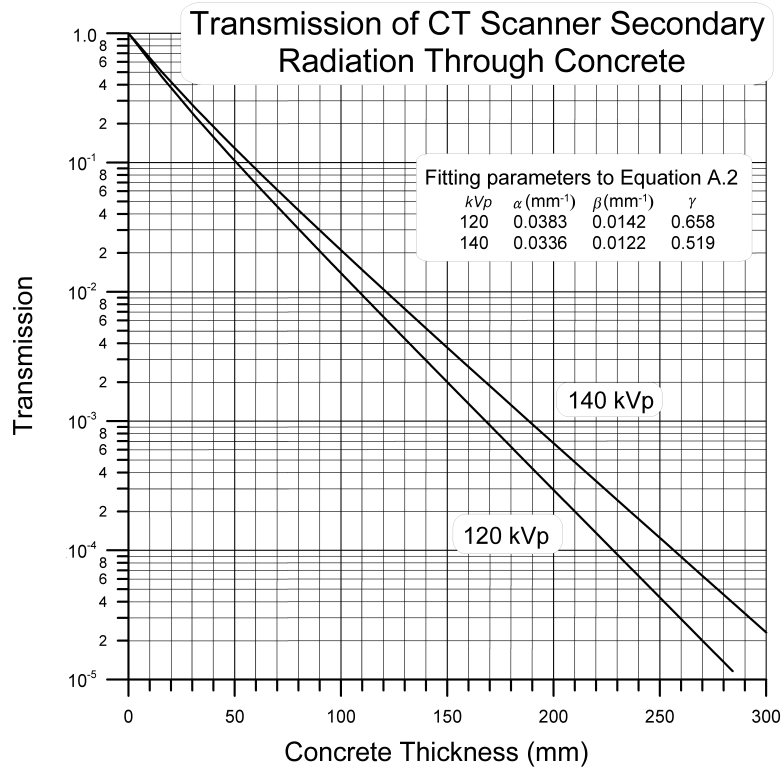

Fig. A.3. Transmission through concrete of secondary radiation from CT scanners [data of Simpkin (1991) fitted to Equation A.2].

Appendix B

Computation of Primary Barrier Thickness

The primary beam is the intense spatially-restricted radiation field which emanates from the x-ray tube portal and is incident on the patient and image receptor. Primary protective barriers are found in radiographic rooms, dedicated chest installations, as well as radiographic and fluoroscopic (R&F) rooms. Primary barriers include the wall on which the vertical cassette holder assembly is mounted, the floor, and those walls toward which the primary beam may be occasionally directed. Since the image intensifier in general fluoroscopy, cardiac and peripheral angiography (as well as neuroangiography), and the breast support tray in mammography are required by regulation to act as primary beam stops, these rooms do not normally contain primary barriers.

Let $K_W^1(kVp)$ be the primary beam air kerma per unit workload $\{i.e., [K_p^1(kVp)]/W\}$ (in $mGy\ mA^{-1}\ min^{-1}$) at 1 m from the x-ray source operated at potential kVp . Values of $K_W^1(kVp)$ for individual x-ray tubes will depend on the generator voltage waveform, anode material, filtration, and anode angle. Figure B.1 shows $K_W^1(kVp)$ for typical molybdenum-anode, molybdenum-filtered mammography beams at and below 35 kVp, and a typical three-phase 12-pulse generated tungsten-anode, aluminum-filtered radiographic beam at above 40 kVp (Archer *et al.*, 1994). In what follows, these beams will be taken as representative of modern clinical practice.

Assume that the workload for this x-ray tube is known as a function of operating potential [*i.e.*, $W(kVp)$]. The unattenuated primary air kerma 1 m from the source due to the workload of this x-ray tube at operating potential kVp is:

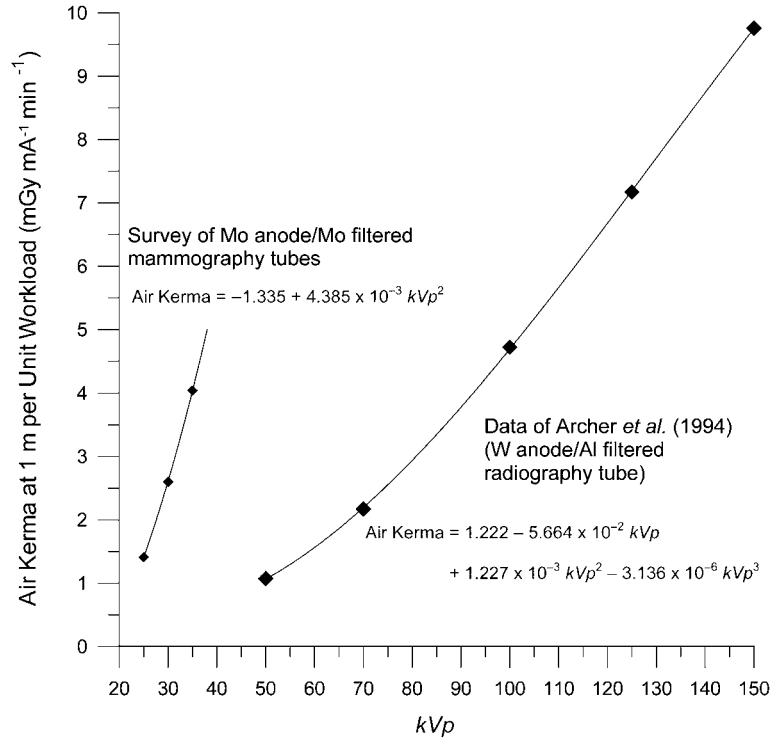

Fig. B.1. The primary beam air kerma per unit workload at 1 m [$K_W^1(kVp)$].

$$K_p^1(kVp) = K_W^1(kVp) W(kVp). \quad (\text{B.1})$$

At distance d_p from the focal spot of an x-ray tube, the total primary air kerma due to use factor-corrected workload [$U W(kVp)$] is:

$$K_p(0, kVp) = \frac{K_W^1(kVp) U W(kVp)}{d_p^2}. \quad (\text{B.2})$$

Behind a barrier of total thickness x_{tot} , whose transmission to primary x rays at this operating potential is $B_p(x_{\text{tot}}, kVp)$, the shielded air kerma is:

$$K_p(x_{\text{tot}}, kVp) = \frac{K_W^1(kVp) U W(kVp)}{d_p^2} B_p(x_{\text{tot}}, kVp), \quad (\text{B.3})$$

and the total shielded air kerma [$K_P(x_{tot})$] in the occupied area due to all operating potentials is:

$$K_P(x_{tot}) = \sum_{kVp} K_P(x_{tot}, kVp) = \sum_{kVp} \frac{K_W^1(kVp) U W(kVp)}{d_P^2} B_P(x_{tot}, kVp), \quad (B.4)$$

For the workload distributions shown in Table 4.2, the unshielded primary beam x-ray air kerma per patient at 1 m (K_P^1) has been calculated from Equation B.4 assuming $x_{tot} = 0$ and $d_P = 1$ m. These values are shown in Table 4.5. Table 4.5 also gives W_{norm} , the workload per patient summed over all kVp intervals in the workload distribution.

The primary transmission curves for the workload distributions which utilize primary beams were calculated by summing the incremental air kerma in each kVp interval transmitted through a given barrier thickness and dividing that by the total air kerma expected with no barrier. These workload-distribution-specific primary beam transmission curves are shown in Figures B.2 through B.6 for lead, concrete, steel, gypsum wallboard, and plate glass. Table B.1 lists the fitting parameters for these curves to Equation A.2.

For an x-ray tube whose total workload W_{tot} is due to N patients:

$$W_{tot} = N W_{norm}. \quad (B.5)$$

In what follows, the qualified expert may therefore substitute the ratio W_{tot}/W_{norm} for N , the number of patients examined per week.

If the primary beam is directed at the occupied area only a fraction U of the time, the number of patients (N) (or, equivalently, the total workload W_{tot}) is scaled by the use factor. At distance d_P from the focal spot of the x-ray tube, the unshielded primary air kerma [$K_P(0)$] is then:

$$K_P(0) = \frac{K_P^1 N U}{d_P^2}. \quad (B.6)$$

If the occupied area is shielded by a barrier of a given material and thickness x having primary transmission $B_P(x)$, then the air kerma to the occupied area is:

$$K_P(x) = \frac{K_P^1 N U}{d_P^2} B_P(x). \quad (B.7)$$

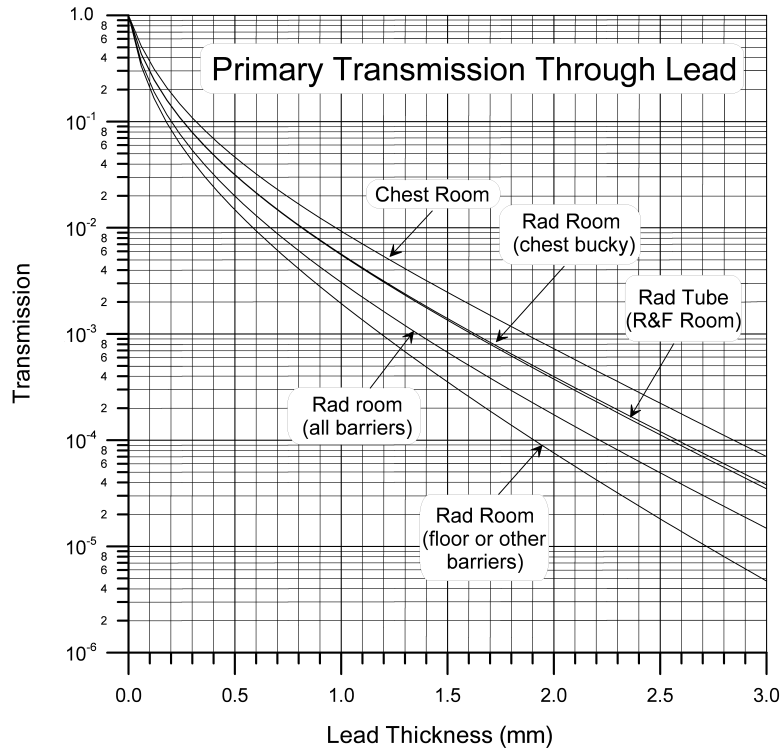

Fig. B.2. Primary broad-beam transmission through lead calculated for the clinical workload distributions in Table 4.2.

A barrier of thickness x_{barrier} will reduce the primary air kerma $[K_P(x_{\text{barrier}})]$ at d_p to the shielding design goal adjusted for the occupancy factor (*i.e.*, P/T). Thus:

$$B_P(x_{\text{barrier}}) = \frac{P d_p^2}{K_p^1 U T N}. \quad (\text{B.8})$$

The shielding task is then to find the barrier whose thickness x_{barrier} satisfies Equation B.8. This may be achieved graphically using the transmission curves in Figures B.2 through B.6. Equivalently, the acceptable primary barrier thickness can be calculated in closed form by substituting the transmission from Equation B.8 into Equation A.3. Thus:

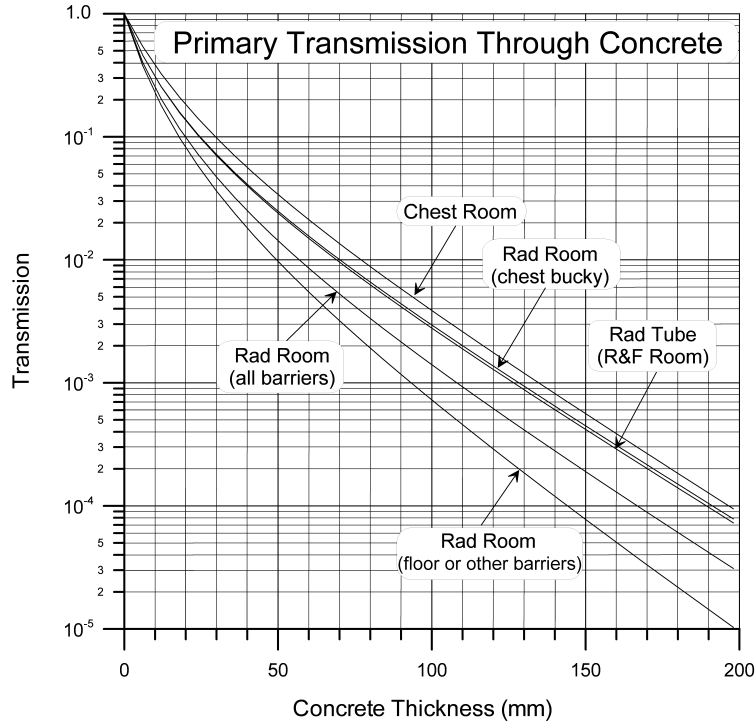

Fig. B.3. Primary broad-beam transmission through concrete calculated for the clinical workload distributions in Table 4.2.

$$x_{\text{barrier}} = \frac{1}{\alpha\gamma} \ln \left[\frac{\left(\frac{K_P^1 U T N}{P d_P^2} \right)^\gamma + \frac{\beta}{\alpha}}{1 + \frac{\beta}{\alpha}} \right]. \quad (\text{B.9})$$

If, as discussed in Section 4.1.6.2, the image receptor is available to provide attenuation of the primary beam before it strikes the structural barrier, the thickness of the required structural barrier may be reduced by the equivalent “preshielding” material x_{pre} (Table 4.6).

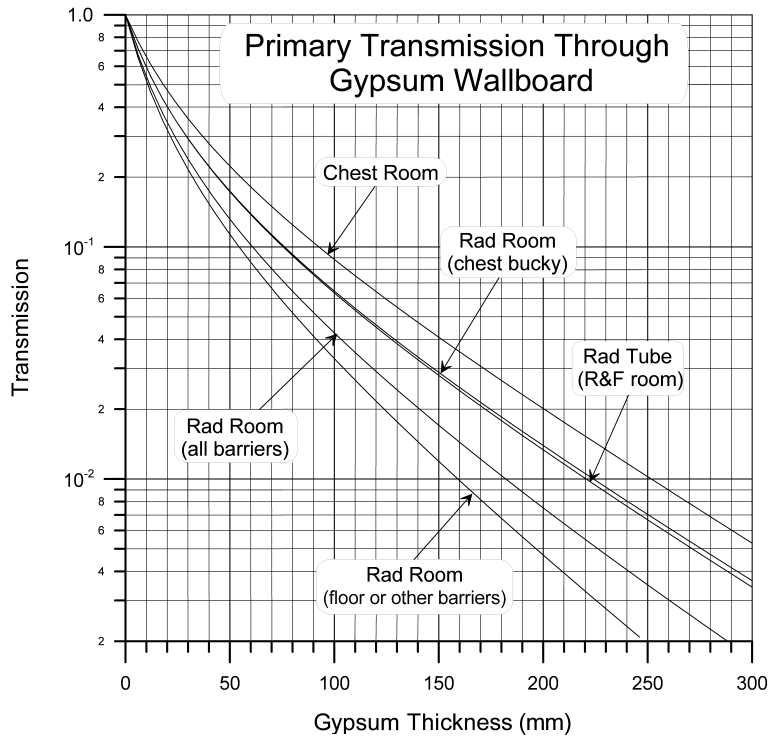

Fig. B.4. Primary broad-beam transmission through gypsum calculated for the clinical workload distributions in Table 4.2. A nominal 5/8 inch sheet of “Type X” gypsum wallboard has a minimum gypsum thickness of ~14 mm.

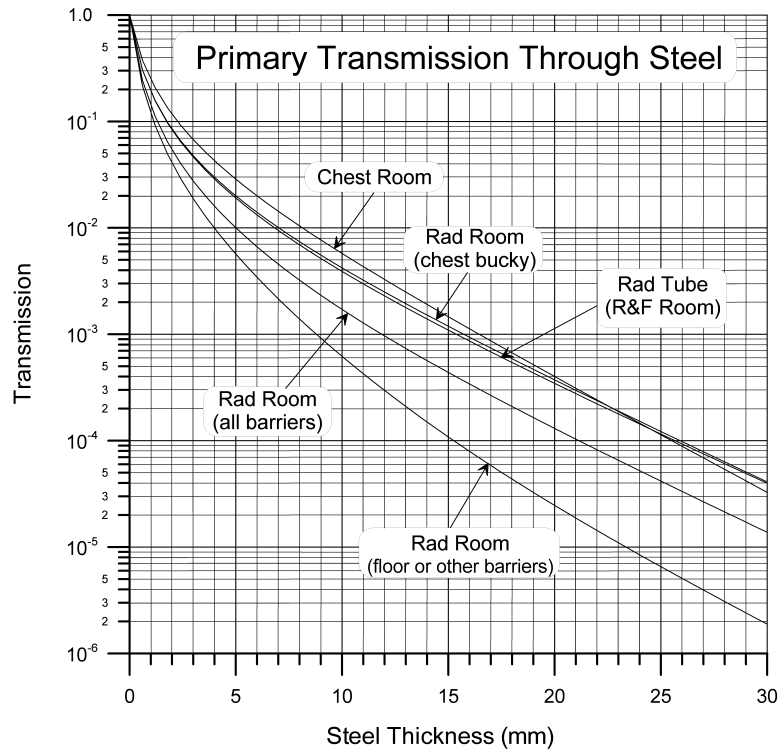

Fig. B.5. Primary broad-beam transmission through steel calculated for the clinical workload distributions in Table 4.2.

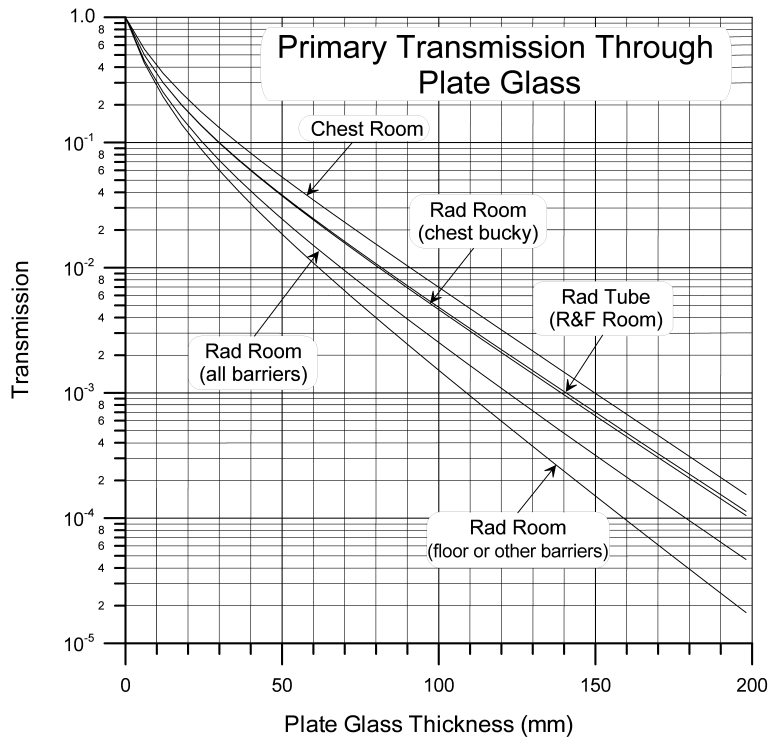

Fig. B.6. Primary broad-beam transmission through plate glass calculated for the clinical workload distributions in Table 4.2.

TABLE B.1—Fitting parameters for transmission of broad primary x-ray beams to Equation A.2 (thickness x is input in millimeters).

Workload Distribution ^a	Lead			Concrete ^b			Gypsum Wallboard		
	α (mm ⁻¹)	β (mm ⁻¹)	γ	α (mm ⁻¹)	β (mm ⁻¹)	γ	α (mm ⁻¹)	β (mm ⁻¹)	γ
Rad Room (all barriers)	2.346	1.590×10^1	4.982×10^{-1}	3.626×10^{-2}	1.429×10^{-1}	4.932×10^{-1}	1.420×10^{-2}	5.781×10^{-2}	7.445×10^{-1}
Rad Room (chest bucky)	2.264	1.308×10^1	5.600×10^{-1}	3.552×10^{-2}	1.177×10^{-1}	6.007×10^{-1}	1.278×10^{-2}	4.848×10^{-2}	8.609×10^{-1}
Rad Room (floor or other barriers)	2.651	1.656×10^1	4.585×10^{-1}	3.994×10^{-2}	1.448×10^{-1}	4.231×10^{-1}	1.679×10^{-2}	6.124×10^{-2}	7.356×10^{-1}
Fluoroscopy Tube (R&F room)	2.347	1.267×10^1	6.149×10^{-1}	3.616×10^{-2}	9.721×10^{-2}	5.186×10^{-1}	1.340×10^{-2}	4.283×10^{-2}	8.796×10^{-1}
Rad Tube (R&F room)	2.295	1.300×10^1	5.573×10^{-1}	3.549×10^{-2}	1.164×10^{-1}	5.774×10^{-1}	1.300×10^{-2}	4.778×10^{-2}	8.485×10^{-1}
Chest Room	2.283	1.074×10^1	6.370×10^{-1}	3.622×10^{-2}	7.766×10^{-2}	5.404×10^{-1}	1.286×10^{-2}	3.505×10^{-2}	9.356×10^{-1}
Mammography Room	3.060×10^1	1.776×10^2	3.308×10^{-1}	2.577×10^{-1}	1.765	3.644×10^{-1}	9.148×10^{-2}	7.090×10^{-1}	3.459×10^{-1}
Cardiac Angiography	2.389	1.426×10^1	5.948×10^{-1}	3.717×10^{-2}	1.087×10^{-1}	4.879×10^{-1}	1.409×10^{-2}	4.814×10^{-2}	8.419×10^{-1}
Peripheral Angiography ^c	2.728	1.852×10^1	4.614×10^{-1}	4.292×10^{-2}	1.538×10^{-1}	4.236×10^{-1}	1.774×10^{-2}	6.449×10^{-2}	7.158×10^{-1}

Workload Distribution ^a	Steel		Plate Glass			Wood			
	α (mm ⁻¹)	β (mm ⁻¹)	γ	α (mm ⁻¹)	β (mm ⁻¹)	γ	α (mm ⁻¹)	β (mm ⁻¹)	γ
<i>Rad Room (all barriers)</i>	2.163×10^{-1}	3.101	5.745×10^{-1}	3.907×10^{-2}	1.069×10^{-1}	5.940×10^{-1}	7.616×10^{-3}	7.670×10^{-4}	1.027
<i>Rad Room (chest bucky)</i>	2.179×10^{-1}	2.677	7.209×10^{-1}	3.762×10^{-2}	9.751×10^{-2}	7.867×10^{-1}	7.142×10^{-3}	3.080×10^{-4}	1.617
<i>Rad Room (floor or other barriers)</i>	2.535×10^{-1}	2.740	4.297×10^{-1}	4.361×10^{-2}	1.082×10^{-1}	5.463×10^{-1}	7.915×10^{-3}	8.800×10^{-4}	9.790×10^{-1}
<i>Fluoroscopy Tube (R&F room)</i>	2.323×10^{-1}	2.190	6.509×10^{-1}	3.901×10^{-2}	8.588×10^{-2}	8.081×10^{-1}	7.089×10^{-3}	4.740×10^{-4}	1.580
<i>Rad Tube (R&F room)</i>	2.126×10^{-1}	2.568	6.788×10^{-1}	3.778×10^{-2}	9.365×10^{-2}	7.483×10^{-1}	7.162×10^{-3}	4.110×10^{-4}	1.541
<i>Chest Room</i>	2.500×10^{-1}	1.989	7.721×10^{-1}	3.866×10^{-2}	7.721×10^{-2}	9.843×10^{-1}	7.650×10^{-3}	-9.800×10^{-4}	8.083×10^{-2}
<i>Mammography Room</i>	5.998	4.291×10^1	3.927×10^{-1}	2.467×10^{-1}	1.654	3.694×10^{-1}	1.914×10^{-2}	4.166×10^{-2}	2.858×10^{-1}
<i>Cardiac Angiography</i>	2.533×10^{-1}	2.461	6.243×10^{-1}	4.025×10^{-2}	9.482×10^{-2}	7.523×10^{-1}	7.303×10^{-3}	7.220×10^{-4}	1.204
<i>Peripheral Angiography^c</i>	3.670×10^{-1}	3.260	5.036×10^{-1}	4.642×10^{-2}	1.203×10^{-1}	5.763×10^{-1}	8.103×10^{-3}	8.440×10^{-4}	9.754×10^{-1}

^aThe workload distributions are those surveyed by AAPM TG9 (Simpkin, 1996a), listed in Table 4.2.

^bNote that the fitting parameters for concrete assume standard-weight concrete.

^cThe data in this Table for *Peripheral Angiography* also apply to *Neuroangiography*.

Appendix C

Computation of Secondary Barrier Thickness

Secondary radiation is an unavoidable consequence of the primary x-ray beam. Barriers that are otherwise never struck by the primary beam must therefore serve as adequate shields against scattered and leakage radiations. In some x-ray imaging situations, regulations require the primary beam to be completely intercepted by an absorbing barrier behind or incorporated into the image receptor. This is the case for operation of an image intensifier and dedicated mammography systems. The air kerma to an occupied area from primary radiation for these cases is thus assumed to be negligible and only scattered and leakage radiations will need to be considered.

C.1 Scattered Radiation

The intensity of x rays scattered off the patient is dependent on the scattering angle θ (defined from the direction of the center of the primary beam to a ray pointing to the occupied area), the number of primary photons incident on the patient, the primary beam photon energy, and the location of the x-ray beam on the patient. It is assumed that the number of primary photons incident on the patient varies linearly with the x-ray beam field size. Thus for fixed kVp , mAs , and collimator jaw opening, the scattered radiation intensity is independent of the distance from the primary x-ray source to the patient.

Trout and Kelley (1972) made a series of widely accepted radiographic scattered radiation measurements 100 cm from the center of a phantom which were then related to the primary air kerma at 1 m. This ratio of scattered to primary air kerma, when divided by the primary beam field size at 1 m primary distance, defines the scatter fraction (a_1). Unfortunately, the filtration of the x-ray

beams used by Trout and Kelley (1972) at 50 and 70 kVp are not typical of x-ray systems used today, invalidating their results at these lower potentials. Dixon (1994) repeated their measurement for 90 degree scatter over a range of operating potentials, and the results indicate a linear increase in a_1 with kVp . The data from Trout and Kelley (1972) at 100, 125 and 150 kVp have been reanalyzed (Simpkin and Dixon, 1998) for a_1 , measured per cm^2 of primary beam area at 1 m. The values for a_1 at lower operating potentials were obtained using linear extrapolation in kVp . The scatter fraction a_1 is broadly distributed over a range of beam sizes, with coefficients of variation on the order of 30 percent. Figure C.1 shows a_1 scaled by 10^{-6} (*i.e.*, values taken from Figure C.1 need to be multiplied by 10^{-6}) determined from Trout and Kelley (1972) at the mean plus one standard deviation level, as a function of scattering angle and operating potential. Figure C.1 also shows a_1 for mammographic beams measured by Simpkin (1996b).

Consider the primary beam from an x-ray tube incident on a patient. At 1 m primary distance, with an area of 1 cm^2 , this tube delivers primary air kerma K_p^1 at operating potential kVp [*i.e.*, $K_p^1(kVp)$]. By the definition of the scaled scatter fraction a_1 , at scattering angle θ , the unshielded air kerma 1 m from the center of the patient due to scattered radiation is:

$$K_S(\theta, kVp) = K_p^1(kVp) a_1(\theta, kVp) \times 10^{-6}. \quad (\text{C.1})$$

Note that the scaled scatter fraction (a_1) read from Figure C.1, has values between 0.1 and 8.

At the scattered radiation distance d_S (meters) from the center of the patient, the scattered air kerma is modified by d_S^{-2} . As noted above, it is assumed that the scattered air kerma scales linearly with the primary x-ray beam area. If the primary beam area size is F at primary radiation distance d_F (meters), then the field size at 1 m primary radiation distance is $F d_F^{-2}$. In medical x-ray imaging, it is convenient to take F as the image-receptor area and d_F as the source-to-image-receptor distance (SID). Thus, the unshielded scattered air kerma $K_S(\theta, kVp)$ at the scattered radiation distance d_S from the patient is given by:

$$K_S(\theta, kVp) = \frac{K_p^1(kVp) a_1(\theta, kVp) \times 10^{-6} F}{d_S^2 d_F^2}. \quad (\text{C.2})$$

Note that, as in Equation B.1, $K_p^1(kVp)$ is $K_w^1(kVp) W(kVp)$. Behind a shielding barrier of thickness x having transmission $B(x, kVp)$, assumed identical to that of the primary beam, the scattered air kerma is:

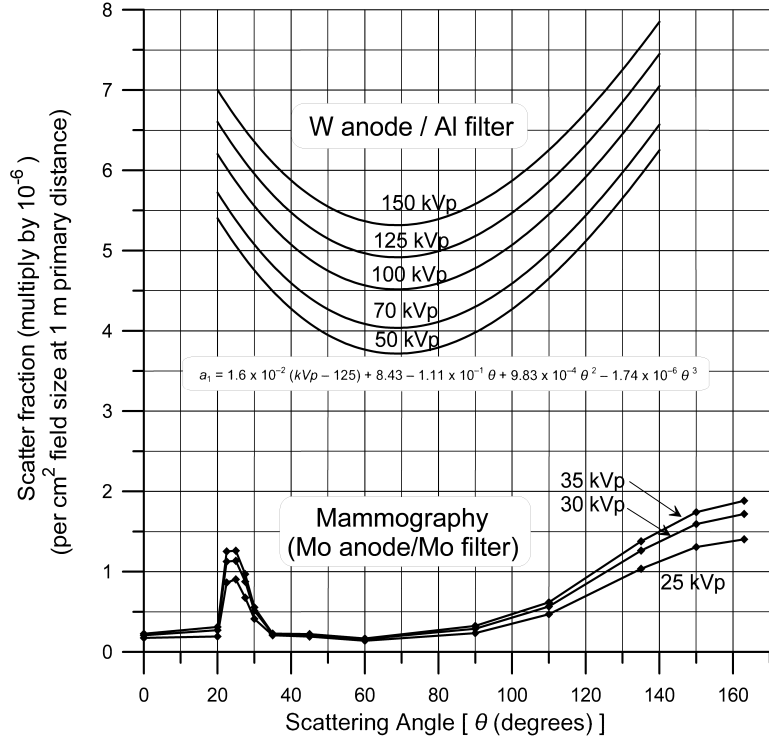

Fig. C.1. The scatter fraction $a_1 \times 10^{-6}$ (i.e., multiply graph value by 10^{-6}) per cm^2 of primary beam area at 1 m. [Data of Trout and Kelley (1972) reanalyzed by Simpkin and Dixon (1998) for tungsten anode, aluminum-filtered beams. Data of Simpkin (1996b) for molybdenum anode, molybdenum filtered mammographic beams.]

$$K_S(x, \theta, kVp) = \frac{K_W^1(kVp) W(kVp) a_1(\theta, kVp) \times 10^{-6}}{d_S^2} \frac{F}{d_F^2} B(x, kVp). \quad (C.3)$$

If a fraction U of the x-ray tube workload is expended as a primary beam directed at this barrier, the workload available to generate scattered radiation on this barrier should be reduced (Simpkin, 1987b) from $W(kVp)$ to $(1 - U)W(kVp)$. Then:

$$K_S(x, \theta, kVp) = \frac{K_W^1(kVp) (1 - U) W(kVp) a_1(\theta, kVp) \times 10^{-6}}{d_S^2} \frac{F}{d_F^2} B(x, kVp). \quad (C.4)$$

For tube operation over a range of potentials, the total scattered air kerma is the sum over the operating potentials:

$$K_S(x, \theta) = \sum_{kVp} K_S(x, \theta, kVp). \quad (\text{C.5})$$

C.2 Leakage Radiation

Leakage radiation is limited by regulation to 100 mR h⁻¹ at 1 m at the maximum operating potential kVp_{max} and the maximum tube current in milliamperes (I_{max}) at which the tube can be operated continuously. For radiographic tubes, this is typically 150 kVp at 3 to 5 mA, and for mammographic tubes it is 50 kVp at 5 mA. The amount of shielding required in the housing to limit transmission to the regulatory limit is based on these techniques, even though the tube is rarely operated at these techniques.

A model predicting the leakage air kerma for tube operation at potential kVp can be developed by assuming that the leakage air-kerma rate for operation without housing matches the primary beam air-kerma rate. The thickness of the lead-lined housing can then be specified by knowing the leakage radiation technique factors, the primary transmission curves, the leakage air-kerma rate limit K_{lim} , and assuming that the primary air-kerma rate varies as kVp^2 . The leakage air-kerma rate 1 m from the x-ray tube operated at potential kVp and tube current I is then:

$$\dot{K}_L(kVp) \propto kVp^2 I B_{\text{housing}}(kVp), \quad (\text{C.6})$$

where $B_{\text{housing}}(kVp)$ is the transmission through the tube housing. For leakage radiation technique factors of 150 kVp at 3.3 mA, a lead-lined housing 2.32 mm thick is required to reduce the leakage radiation exposure rate at 1 m to 100 mR h⁻¹ (0.876 mGy h⁻¹; 1.46×10^{-2} mGy min⁻¹). The ratio of the leakage air-kerma rates at 1 m at clinical parameters kVp and I to that at the maximum values of the leakage radiation technique factors yields:

$$\dot{K}_L(kVp) = \frac{\dot{K}_{\text{lim}} kVp^2 B_{\text{housing}}(kVp) I}{kVp_{\text{max}}^2 B_{\text{housing}}(kVp_{\text{max}}) I_{\text{max}}}. \quad (\text{C.7})$$

Note that this assumes the highest allowed air-kerma rate at the leakage radiation technique factors. This is usually assumed to be conservatively safe by factors of at least 2 to 10. Integrating Equation C.7 over time yields the leakage air kerma (K_L) accumulated due to operation at potential kVp and workload $W(kVp)$. The

workload is the time integral of the tube current. Consider an area located at leakage radiation distance d_L from the x-ray tube. The transmission of leakage radiation through a shielding barrier of thickness x will be $e^{[-(\ln 2) x/x_{1/2}(kVp)]}$ where $x_{1/2}(kVp)$ is the HVL through the barrier material at high attenuation. The values of $x_{1/2}(kVp)$ are shown in Figure A.1. If a fraction U of the x-ray tube workload is expended as a primary beam directed at this barrier, the workload available to generate leakage radiation on this barrier should be reduced (Simpkin, 1987b) from $W(kVp)$ to $(1 - U)W(kVp)$. The leakage air kerma to this shielded area is then:

$$K_L(x, kVp) = \frac{\dot{K}_{\text{lim}} kVp^2 B_{\text{housing}}(kVp) (1 - U) W(kVp) e^{\left[\frac{-(\ln 2)x}{x_{1/2}(kVp)}\right]}}{kVp_{\text{max}}^2 B_{\text{housing}}(kVp_{\text{max}}) I_{\text{max}}} \frac{1}{d_L^2}, \quad (\text{C.8})$$

with the total leakage air kerma equal to the sum over the operating potentials in the workload:

$$K_L(x) = \sum_{kVp} K_L(x, kVp). \quad (\text{C.9})$$

C.3 Total Secondary Barrier and Secondary Transmission

Consider a radiation barrier that is not struck by primary radiation. The total air kerma behind this secondary radiation barrier will be due only to secondary radiations. The total secondary air kerma $[K_{\text{sec}}(x)]$, behind a secondary barrier of thickness x is the sum of the scattered and leakage air kermas. Dropping the θ dependence on K_S :

$$K_{\text{sec}}(x) = K_S(x) + K_L(x). \quad (\text{C.10})$$

The unshielded scattered, leakage, and total secondary air kermas are predicted by Equations C.5, C.9, and C.10 with $x = 0$. Table 4.7 shows the unshielded scattered, leakage, and total secondary air kermas at 1 m calculated for a variety of workload distributions at typical x-ray beam sizes and leakage radiation technique factors. The unshielded secondary air kerma at 1 m from constant kVp operation is also available (Simpkin and Dixon, 1998). The total unshielded secondary air kermas in Table 4.7 (K_{sec}^1) were calculated for radiation scattered at 90 degrees ("side-scatter") and 135 degrees ("forward- and backscatter") assuming distances $d_S = d_L = d_{\text{sec}}$. The workload distributions for the clinical sites are taken from the survey of clinical workloads

(Simpkin, 1996a), with total workload per patient (W_{norm}) equal to the average workload per patient reported by the survey. The unshielded secondary air kerma is seen to be due almost exclusively to scattered radiation. It is, however, anticipated that beam hardening in the barrier will substantially increase the contribution of leakage radiation to the air kerma in the shielded area, so it is prudent to not ignore leakage radiation in a shielding calculation.

The ratio of the secondary air kerma behind a barrier of thickness x to the unshielded secondary air kerma, defines the secondary transmission $B_{\text{sec}}(x)$:

$$B_{\text{sec}}(x) = \frac{K_{\text{sec}}(x)}{K_{\text{sec}}(0)}. \quad (\text{C.11})$$

Figures C.2 through C.7 show the transmission of secondary radiation through lead, concrete, gypsum wallboard, steel, plate glass, and wood for the surveyed clinical workload distributions in Table 4.2.¹⁴ The fitting parameters of the transmission curves in Figures C.2 through C.7 to Equation A.2 are given in Table C.1. These curves assume 90 degree scattered radiation, that the transmission of scattered radiation matches that of the primary beam, and that distance $d_s = d_L$. Note that the choice of 90 degree scattered radiation is conservatively safe, in that, the scatter fraction at 90 degrees is relatively small leading to a smaller scattered radiation contribution to the secondary air kerma. The secondary transmission will be greater with the low value of the scattered radiation fraction, since the more penetrating leakage radiation will have a greater contribution to the secondary air kerma. At low (<100 kVp) operating potentials, the leakage radiation contribution through the tube housing is negligible so that the secondary transmission is little different from the primary transmission. At higher potentials, the increased penetration of leakage radiation makes the secondary transmission exceed the primary. This is most pronounced for lead and steel. For 100 kVp x rays, the secondary transmission through a typical 1.58 mm (1/16 inch) lead barrier exceeds the primary transmission by 50 percent.

Given knowledge of the secondary air kerma per patient (or known workload per patient W_{norm}) and the secondary transmission, a simple shielding protocol for secondary radiations may be developed. The unshielded secondary air kerma at 1 m for N patients (or equivalently, total workload per week W_{tot}) is:

¹⁴The data given in Figures C.2 through C.7 for Peripheral Angiography also apply to Neuroangiography.

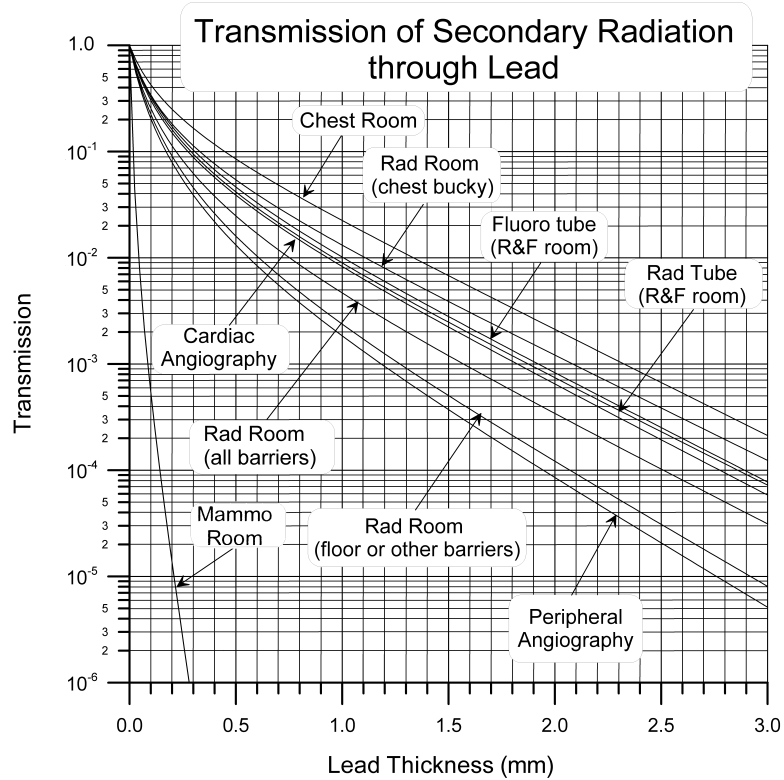

Fig. C.2. Transmission of secondary radiation through lead for the clinical workload distributions given in Table 4.2. This assumes 90 degree scattered radiation, primary beam sizes listed in Table 4.7, and leakage radiation technique factors of 150 kVp at 3.3 mA.

$$K_{\text{sec}}^1 N = K_{\text{sec}}^1 \frac{W_{\text{tot}}}{W_{\text{norm}}} \quad (\text{C.12})$$

An inverse square correction is needed to extrapolate the unshielded secondary air kerma to distance d_{sec} :

$$K_{\text{sec}}(0) = \frac{K_{\text{sec}}^1 N}{d_{\text{sec}}^2} \quad (\text{C.13})$$

The secondary air kerma will be attenuated in a barrier of secondary transmission $[B_{\text{sec}}(x)]$, so that the transmitted secondary air kerma through the shielding barrier is:

$$K_{\text{sec}}(x) = \frac{K_{\text{sec}}^1 N}{d_{\text{sec}}^2} B_{\text{sec}}(x) \quad (\text{C.14})$$

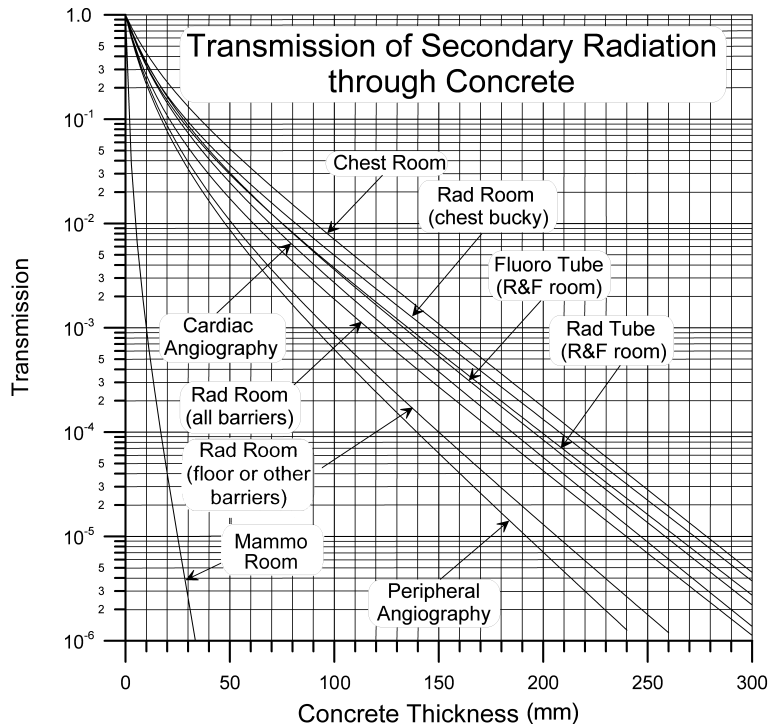

Fig. C.3. Transmission of secondary radiation through standard-weight concrete (data as in Figure C.2).

An acceptable barrier thickness x_{barrier} is one that limits the transmitted secondary air kerma to P/T , so that:

$$B_{\text{sec}}(x_{\text{barrier}}) = \frac{P}{T} \frac{d_{\text{sec}}^2}{K_{\text{sec}}^1 N} \quad (\text{C.15})$$

Using the fitting parameters to Equation A.3 in Table C.1 to describe the secondary radiation transmission curves, the required barrier thickness may be determined algebraically.

C.4 The General Case

The techniques in the preceding sections provide methods for calculating the air kerma in a shielded and unshielded occupied area from an x-ray tube, given assumptions about the use of the tube, room geometry, and type of occupancy. Only in the simplest

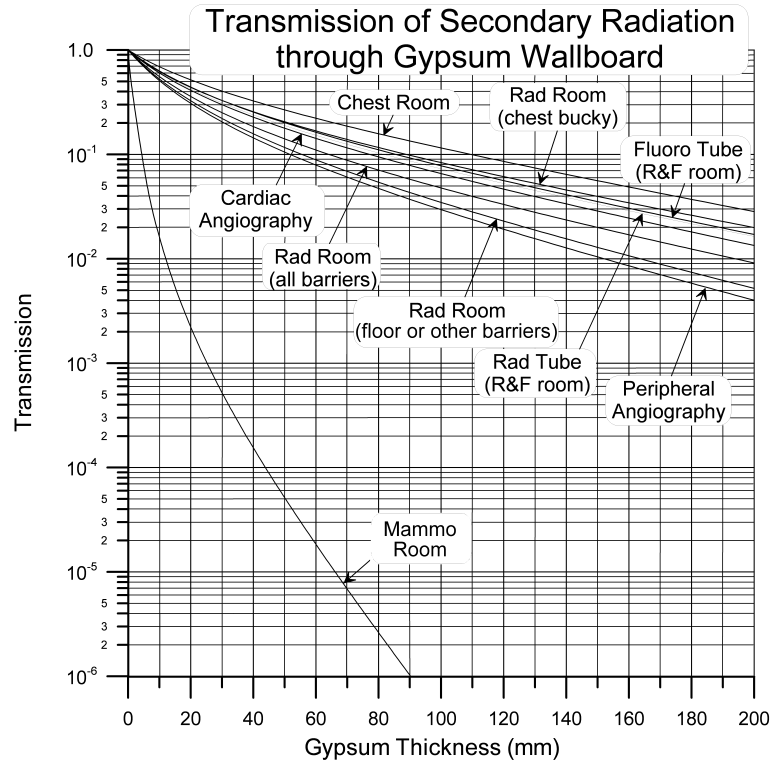

Fig. C.4. Transmission of secondary radiation through gypsum wallboard (data as in Figure C.2). A nominal 5/8 inch sheet of "Type X" gypsum wallboard has a minimum gypsum thickness of approximately 14 mm.

situations is it possible to precisely prescribe the thickness of the shielding barrier that will decrease the transmitted air kerma to the shielding design goal. These cases include single x-ray tubes in fixed geometry, or multiple x-ray tubes each having the same transmission through the barrier. In the more general case, multiple x-ray tubes, or single tubes used in different locations generating x rays of varying transmission, will each contribute to the total air kerma through a barrier. The thickness of that barrier required to decrease the transmitted radiation to a given level can be found by a number of approximation techniques, all of which tend to achieve accuracy at the price of computational complexity.

Consider a medical x-ray imaging installation containing multiple x-ray sources contributing varying amounts of primary and secondary radiation generated over a variety of operating potentials.

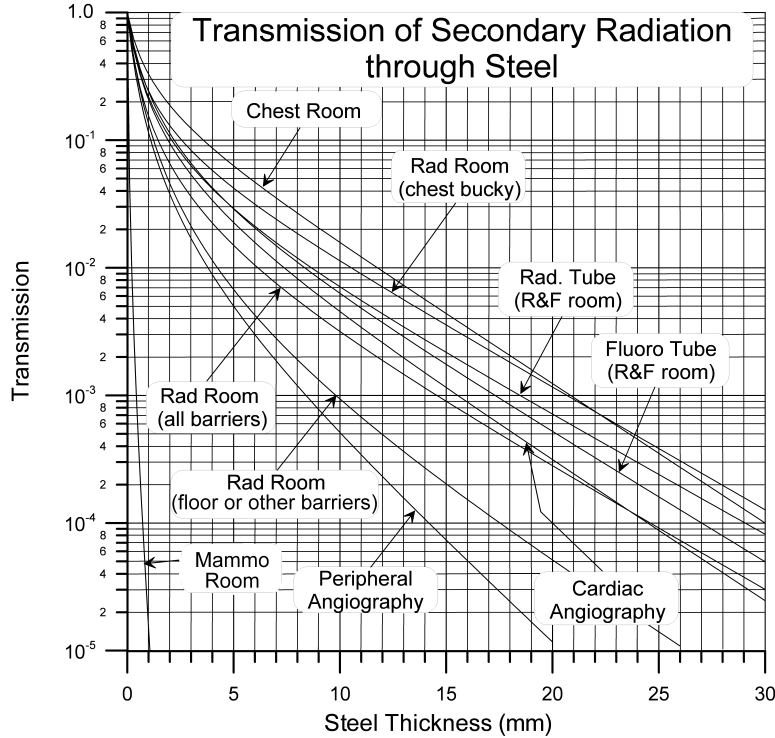

Fig. C.5. Transmission of secondary radiation through steel (data as in Figure C.2).

The total air kerma through a barrier of thickness x [i.e., $K_{tot}(x)$] from the x-ray tubes of the installation, each x-ray tube generating primary air kerma $K_{p_{tube}}$, scattered air kerma $K_{s_{tube}}$, and leakage air kerma $K_{L_{tube}}$ from operation at potential kVp is:

$$K_{tot}(x) = \sum_{tubes} \sum_{kVp} [K_{p_{tube}}(x, kVp) + K_{s_{tube}}(x, kVp) + K_{L_{tube}}(x, kVp)]. \quad (C.16)$$

The task for the shielding designer is to determine the thickness $x_{barrier}$ that reduces $K_{tot}(x_{barrier})$ to P/T .

A simple technique is to use the methods of Appendices B and C to:

1. calculate the unshielded air kermas from each x-ray tube,
2. sum the air kermas to determine the total unshielded air kerma,

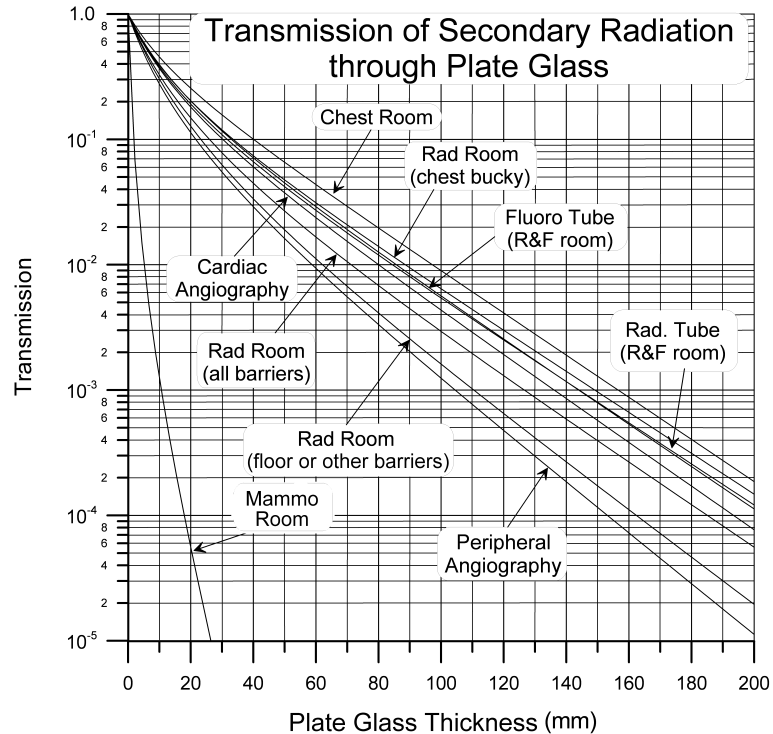

Fig. C.6. Transmission of secondary radiation through plate glass (data as in Figure C 2).

3. take the ratio of P/T to the total unshielded air kerma as the required barrier transmission, and
4. from the most penetrating of the transmission curves for the x-ray sources in the room, graphically estimate the barrier thickness required to give this transmission.

This procedure will generally be conservatively safe, and will prove accurate if the transmission curves of the various x-ray sources are similar.

A useful, although computationally more intensive, technique is to find by iteration the barrier thickness that decreases the sum of the transmitted air kerma contributions to P/T . Consider two test barrier thicknesses x_1 and x_2 , for which the total transmitted air kerma has been calculated to be K_1 and K_2 , respectively. Assume x_1 and x_2 bound the solution such that, $x_1 < x_2$ and $K_1 > P/T > K_2$. From the shape of the transmission curves, it is reasonable to use

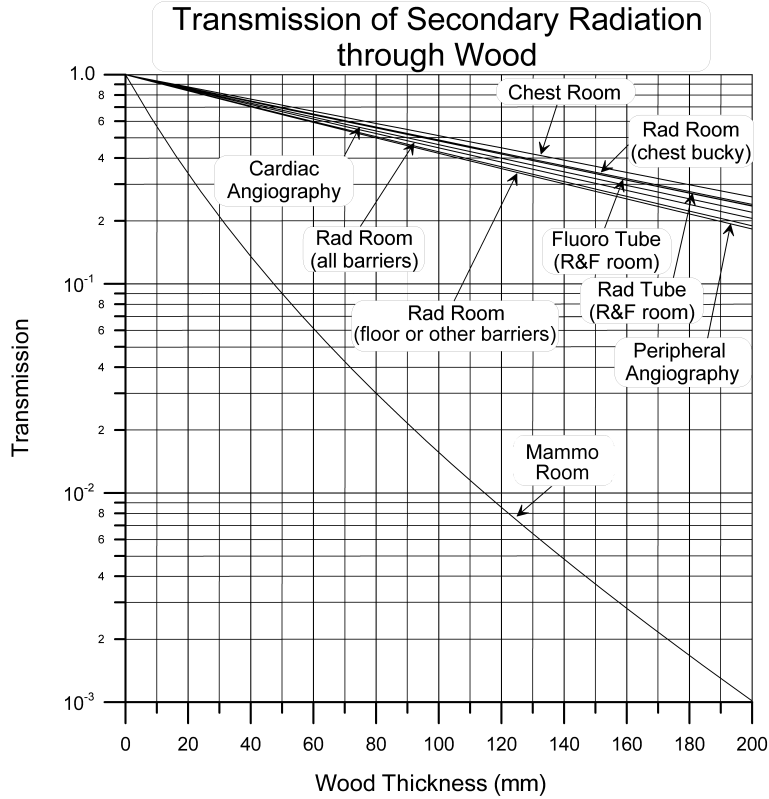

Fig. C.7. Transmission of secondary radiation through wood (data as in Figure C.2).

exponential interpolation to estimate the thickness x_{est} at which the total air kerma is P/T :

$$x_{est} = x_1 + (x_2 - x_1) \frac{\ln\left(\frac{P/T}{K_1}\right)}{\ln\left(\frac{K_2}{K_1}\right)} \quad (C.17)$$

That is, the total air kerma $K_{tot}(x_{est})$ is compared to P/T , and x_{est} is used as a new upper (or lower) bounding thickness. This procedure may be used to find by iteration a value of x_{est} that yields a value of $K_{tot}(x_{est})$ that closely approaches P/T .

TABLE C.1—Fitting parameters of the broad-beam secondary transmission to Equation A.2 (thickness x is input in millimeters).^a

Workload Distribution ^b	Lead			Concrete ^c			Gypsum			Wallboard		
	α (mm ⁻¹)	β (mm ⁻¹)	γ	α (mm ⁻¹)	β (mm ⁻¹)	γ	α (mm ⁻¹)	β (mm ⁻¹)	γ	α (mm ⁻¹)	β (mm ⁻¹)	γ
30 kVp	3.879×10^1	1.800×10^2	3.560×10^{-1}	3.174×10^{-1}	1.725	3.705×10^{-1}	1.198×10^{-1}	7.137×10^{-1}	3.703×10^{-1}	1.198×10^{-1}	7.137×10^{-1}	3.703×10^{-1}
50 kVp	8.801	2.728×10^1	2.957×10^{-1}	9.030×10^{-2}	1.712×10^{-1}	2.324×10^{-1}	3.880×10^{-2}	8.730×10^{-2}	5.105×10^{-1}	3.880×10^{-2}	8.730×10^{-2}	5.105×10^{-1}
70 kVp	5.369	2.349×10^1	5.883×10^{-1}	5.090×10^{-2}	1.697×10^{-1}	3.849×10^{-1}	2.300×10^{-2}	7.160×10^{-2}	7.300×10^{-1}	2.300×10^{-2}	7.160×10^{-2}	7.300×10^{-1}
100 kVp	2.507	1.533×10^1	9.124×10^{-1}	3.950×10^{-2}	8.440×10^{-2}	5.191×10^{-1}	1.470×10^{-2}	4.000×10^{-2}	9.752×10^{-1}	1.470×10^{-2}	4.000×10^{-2}	9.752×10^{-1}
125 kVp	2.233	7.888	7.295×10^{-1}	3.510×10^{-2}	6.600×10^{-2}	7.832×10^{-1}	1.200×10^{-2}	2.670×10^{-2}	1.079	1.200×10^{-2}	2.670×10^{-2}	1.079
150 kVp	1.791	5.478	5.678×10^{-1}	3.240×10^{-2}	7.750×10^{-2}	1.566	1.040×10^{-2}	2.020×10^{-2}	1.135	1.040×10^{-2}	2.020×10^{-2}	1.135
Rad Room (all barriers)	2.298	1.738×10^1	6.193×10^{-1}	3.610×10^{-2}	1.433×10^{-1}	5.600×10^{-1}	1.380×10^{-2}	5.700×10^{-2}	7.937×10^{-1}	1.380×10^{-2}	5.700×10^{-2}	7.937×10^{-1}
Rad Room (chest bucky)	2.256	1.380×10^1	8.837×10^{-1}	3.560×10^{-2}	1.079×10^{-1}	7.705×10^{-1}	1.270×10^{-2}	4.450×10^{-2}	1.049	1.270×10^{-2}	4.450×10^{-2}	1.049
Rad Room (floor or other barriers)	2.513	1.734×10^1	4.994×10^{-1}	3.920×10^{-2}	1.464×10^{-1}	4.486×10^{-1}	1.640×10^{-2}	6.080×10^{-2}	7.472×10^{-1}	1.640×10^{-2}	6.080×10^{-2}	7.472×10^{-1}
Fluoroscopy Tube (R&F room)	2.322	1.291×10^1	7.575×10^{-1}	3.630×10^{-2}	9.360×10^{-2}	5.955×10^{-1}	1.330×10^{-2}	4.100×10^{-2}	9.566×10^{-1}	1.330×10^{-2}	4.100×10^{-2}	9.566×10^{-1}
Rad Tube (R&F room)	2.272	1.360×10^1	7.184×10^{-1}	3.560×10^{-2}	1.114×10^{-1}	6.620×10^{-1}	1.290×10^{-2}	4.570×10^{-2}	9.355×10^{-1}	1.290×10^{-2}	4.570×10^{-2}	9.355×10^{-1}
Chest Room	2.288	9.848	1.054	3.640×10^{-2}	6.590×10^{-2}	7.543×10^{-1}	1.300×10^{-2}	2.970×10^{-2}	1.195	1.300×10^{-2}	2.970×10^{-2}	1.195
Mammography Room	2.991×10^1	1.844×10^2	3.550×10^{-1}	2.539×10^{-1}	1.8411	3.924×10^{-1}	8.830×10^{-2}	7.526×10^{-1}	3.786×10^{-1}	8.830×10^{-2}	7.526×10^{-1}	3.786×10^{-1}
Cardiac Angiography	2.354	1.494×10^1	7.481×10^{-1}	3.710×10^{-2}	1.067×10^{-1}	5.733×10^{-1}	1.390×10^{-2}	4.640×10^{-2}	9.185×10^{-1}	1.390×10^{-2}	4.640×10^{-2}	9.185×10^{-1}
Peripheral Angiography ^d	2.661	1.954×10^1	5.094×10^{-1}	4.219×10^{-2}	1.559×10^{-1}	4.472×10^{-1}	1.747×10^{-2}	6.422×10^{-2}	7.299×10^{-1}	1.747×10^{-2}	6.422×10^{-2}	7.299×10^{-1}

Workload Distribution ^a	Steel			Plate Glass			Wood ^e		
	α (mm ⁻¹)	β (mm ⁻¹)	γ	α (mm ⁻¹)	β (mm ⁻¹)	γ	α (mm ⁻¹)	β (mm ⁻¹)	γ
30 kVp	7.408	4.249×10^1	4.061×10^{-1}	3.060×10^{-1}	1.620	3.793×10^{-1}	2.159×10^{-2}	3.971×10^{-2}	2.852×10^{-1}
50 kVp	1.817	4.840	4.021×10^{-1}	9.721×10^{-2}	1.799×10^{-1}	4.912×10^{-1}	1.076×10^{-2}	1.862×10^{-3}	1.170
70 kVp	7.149×10^{-1}	3.798	5.381×10^{-1}	5.791×10^{-2}	1.357×10^{-1}	5.968×10^{-1}	8.550×10^{-3}	5.390×10^{-4}	1.194
100 kVp	3.424×10^{-1}	2.456	9.388×10^{-1}	4.279×10^{-2}	8.948×10^{-2}	1.029	7.230×10^{-3}	8.940×10^{-4}	1.316
125 kVp	2.138×10^{-1}	1.690	1.086	3.654×10^{-2}	5.790×10^{-2}	1.093	6.587×10^{-3}	-1.140×10^{-3}	1.172
150 kVp	1.511×10^{-1}	1.124	1.151	3.267×10^{-2}	4.074×10^{-2}	1.134	6.027×10^{-3}	-1.630×10^{-3}	1.440
Rad Room (all barriers)	2.191×10^{-1}	3.490	7.358×10^{-1}	3.873×10^{-2}	1.054×10^{-1}	6.397×10^{-1}	7.552×10^{-3}	7.370×10^{-4}	1.044
Rad Room (chest bucky)	2.211×10^{-1}	2.836	1.123	3.749×10^{-2}	8.710×10^{-2}	9.086×10^{-1}	7.058×10^{-3}	2.290×10^{-4}	1.875
Rad Room (floor or other barriers)	2.440×10^{-1}	3.012	5.019×10^{-1}	4.299×10^{-2}	1.070×10^{-1}	5.538×10^{-1}	7.887×10^{-3}	8.770×10^{-4}	9.800×10^{-1}
Fluoroscopy Tube (R&F room)	2.331×10^{-1}	2.213	8.051×10^{-1}	3.886×10^{-2}	8.091×10^{-2}	8.520×10^{-1}	7.057×10^{-3}	4.220×10^{-4}	1.664
Rad Tube (R&F room)	2.149×10^{-1}	2.695	8.768×10^{-1}	3.762×10^{-2}	8.857×10^{-2}	8.087×10^{-1}	7.102×10^{-3}	3.450×10^{-4}	1.698
Chest Room	2.518×10^{-1}	1.829	1.273	3.866×10^{-2}	6.270×10^{-2}	1.128	7.485×10^{-3}	-8.100×10^{-4}	9.459×10^{-2}
Mammography Room	5.798	4.412×10^1	4.124×10^{-1}	2.404×10^{-1}	1.709	3.918×10^{-1}	1.888×10^{-2}	4.172×10^{-2}	2.903×10^{-1}
Cardiac Angiography	2.530×10^{-1}	2.592	7.999×10^{-1}	4.001×10^{-2}	9.030×10^{-2}	8.019×10^{-1}	7.266×10^{-3}	6.740×10^{-4}	1.235
Peripheral Angiography ^d	3.579×10^{-1}	3.466	5.600×10^{-1}	4.612×10^{-2}	1.198×10^{-1}	5.907×10^{-1}	8.079×10^{-3}	8.470×10^{-4}	9.742×10^{-1}

^aThe appropriateness of the fits should not be assumed for barrier thicknesses beyond those plotted in Figures C.2 through C.7.

^bThe 30 kVp and Mammography Room data are for molybdenum-anode x-ray tubes. All other data are for tungsten-anode tubes.

^cThe fitting parameters α , β and γ for concrete assume standard-weight concrete.

^dThe data in this Table for Peripheral Angiography also apply to Neuroangiography.

^eAdditional fitting parameters (α , β and γ) for 25 and 35 kVp molybdenum-anode x-ray tube secondary transmission curves for wood are (2.290×10^{-2} , 4.341×10^{-2} , and 1.937×10^{-1}) for 25 kVp and (1.882×10^{-2} , 3.878×10^{-2} , and 3.825×10^{-1}) for 35 kVp.

Appendix D

Instrumentation for Performing Radiation Protection Surveys

An ionization-chamber survey meter is the most desirable instrument for evaluating the adequacy of protective barriers, due to its relatively flat energy response and air-kerma-rate independence. When the radiation source is a radiographic x-ray unit, an integrating ionization-chamber survey meter of adequate sensitivity is more useful than a device intended to measure air-kerma rate. This is because the response time (time constant) in the “exposure-rate mode” on the lowest ranges for most ionization-chamber survey meters is 3 to 8 s, which is a longer exposure time than many radiographic generators can produce (even at low x-ray tube beam current). In addition, a survey meter in the “exposure-rate mode” will not give an accurate result with a falling load or capacitive discharge x-ray generator. The surveyor must measure the barrier transmission factor $B(x)$, which is the ratio of the air kerma beyond the barrier to the unattenuated air kerma at the same distance. When using the primary beam to determine the barrier transmission, a portable ionization-chamber survey meter may not be suitable for making the unattenuated air-kerma measurement. These portable survey meters are usually large volume ionization chambers with relatively low bias voltages, and collection efficiency will be reduced at the higher air-kerma rates in the unattenuated primary beam. Such portable ionization-chamber survey meters may be limited to air-kerma rates below 0.5 Gy h^{-1} , necessitating a very low x-ray tube beam current for the unattenuated air-kerma measurement. The unattenuated primary air kerma is therefore best measured using a calibrated ionization-chamber/electrometer system designed for primary beam measurements such as is routinely used for measuring x-ray tube outputs. Only one such unattenuated measurement is required, usually at 1 m for a 1 mA min

exposure at 100 kVp. This air-kerma measurement can then be corrected to the appropriate distances using the inverse square law. For a three-phase or high frequency x-ray unit at 100 kVp, this output should be approximately an air kerma of $5 \text{ mGy mA}^{-1} \text{ min}^{-1}$.

The air kerma beyond each of the various barriers is then most conveniently measured using a calibrated, portable ionization-chamber survey meter. In the case where a barrier cannot be tested using the primary beam due to mechanical constraints or a pure fluoroscopic system, the survey meter must be able to measure unattenuated scattered radiation, as well as scattered radiation beyond the barrier.

The survey meter should exhibit a sensitivity down to an air kerma of $0.01 \text{ }\mu\text{Gy}$ (or an air-kerma rate of $1 \text{ }\mu\text{Gy h}^{-1}$) and have a relatively flat photon-energy response over the range of 15 to 150 keV. It must be capable of measuring unattenuated secondary radiation, as well as the radiation penetrating the barrier, which contains only the highest energy photons in the spectrum. The meter should be calibrated for a medical x-ray imaging beam (HVL $\sim 3 \text{ mm}$ aluminum) rather than with a high-energy isotopic source such as ^{137}Cs , unless the energy response for the instrument is such that this is a valid calibration. Linearity of response with air-kerma rate should also be verified over the range of use (*e.g.*, by varying the milliamperere for a constant milliamperere-minutes exposure at 100 kVp or by varying the distance and using the inverse square law). If the same chamber is used for both unattenuated and attenuated measurements, it is necessary that it have a linear response with air-kerma rate over several orders of magnitude, so all ranges should be checked for linearity.

Pressurized ionization-chamber survey meters with increased sensitivity are available. Due to the increased wall thickness, the energy response of some of these meters falls off rapidly below 30 keV, rendering them unsuitable for measurement except in the hardened x-ray beam beyond a lead or concrete barrier.

A GM detector, particularly one with an audible output, is useful for searching for voids or defects in the shielding integrity due to its high sensitivity and relatively rapid response time. An energy-compensated GM detector should not be used to determine the barrier transmission B , unless the linearity of the instrument can be verified over the range of air kerma and pulse rates generated by the radiographic equipment. Microprocessor-controlled GM survey meters are available that make automatic dead-time corrections and have pulse-integrating counting capabilities.

Scintillation probes (sodium iodide crystal with photomultiplier tube) are also available with survey meters and exhibit high sensitivity. They do not, however, exhibit a flat energy response. They may be equipped with a single-channel analyzer for energy discrimination, which is particularly useful with a gamma-ray source. An uncompensated GM or scintillation detector can be used when a monoenergetic gamma-ray source is utilized to determine barrier thickness since energy response is not a significant problem in this case.

A well-equipped surveyor should have both an ionization chamber and a GM survey meter available. An integrate mode on both types is desirable.

In some situations, the flux or fluence of secondary radiation may be too low to measure the air kerma with the ionization-chamber survey meter. Sometimes however, simply determining that the air kerma is below the detection limit is sufficient to ensure the adequacy of the shielding. For example, a reading below the detection limit (*e.g.*, 0.01 μGy) for a 300 mAs exposure in a fully-occupied, uncontrolled area ($P/T = 0.02 \text{ mGy week}^{-1}$) would allow a weekly workload up to 10,000 mA min. In some instances, one may want to use a more sensitive instrument such as a GM (or scintillation) survey meter to get an estimate of the air kerma beyond the barrier. This can be done if the GM meter is cross-compared with the ionization-chamber meter under higher flux conditions, but at a similar beam quality where the radiation has been hardened by penetration of a barrier of similar thickness.

Glossary

- absorbed dose (*D*):** The energy imparted by ionizing radiation to matter per unit mass of irradiated material at the point of interest. In the Systeme Internationale (SI), the unit is joule per kilogram (J kg^{-1}), given the special name gray (Gy). $1 \text{ Gy} = 1 \text{ J kg}^{-1}$.
- air kerma (*K*):** (see **kerma**). Kerma in air. In this Report, the symbol *K* always refers to the quantity air kerma (in place of the usual symbol K_a), followed by an appropriate subscript to further describe the quantity (e.g., K_p is air kerma from primary radiation).
- ampere (*A*):** Unit of electric current. One ampere is produced by one volt acting through a resistance of 1 ohm.
- as low as reasonably achievable (ALARA):** A principle of radiation protection philosophy that requires that exposures to ionizing radiation be kept as low as reasonably achievable, economic and social factors being taken into account. The protection from radiation exposure is ALARA when the expenditure of further resources would be unwarranted by the reduction in exposure that would be achieved.
- attenuation:** The reduction of air-kerma or exposure rate upon passage of radiation through matter. This Report is concerned with broad-beam attenuation (*i.e.*, that occurring when the field area is large at the barrier and the point of measurement is near the exit surface).
- computed tomography (CT):** An imaging procedure that uses multiple x-ray transmission measurements and a computer program to generate tomographic images of the patient.
- computed tomography dose index (CTDI):** A dose index quantity obtained by integrating over the dose profile resulting from a single computed tomography axial rotation. When obtained using a 10 cm (100 mm) long ionization chamber, it is designated $CTDI_{100}$. When normalized per milliamperere-second (*mAs*), it is designated ${}_nCTDI_{100}$.
- concrete equivalence:** The thickness of standard-weight concrete [2.4 g cm^{-3} (147 lb foot^{-3})] affording the same attenuation, under specified conditions, as the material in question.
- controlled area:** A limited-access area in which the occupational exposure of personnel to radiation is under the supervision of an individual in charge of radiation protection. This implies that access, occupancy and working conditions are controlled for radiation protection purposes.
- dose:** (see **absorbed dose**). Often used generically when not referring to a specific quantity, such as absorbed or effective dose.

dose-length product (DLP): A dose index quantity obtained using the following formula:

$$DLP = \frac{L}{p} (1/3 CTDI_{100,center} + 2/3 CTDI_{100,periphery}), \quad (G.1)$$

where L is the length of patient scanned, p is the pitch, and $CTDI_{100,center}$ and $CTDI_{100,periphery}$ are $CTDI_{100}$ values determined at the center and periphery of a standardized phantom (see **pitch** and **computed tomography dose index**).

dose-line integral (DLI): The infinite line integral along a given phantom axis of the accumulated absorbed dose $D(z)$ for a CT scan series, where z is the distance along the axis of rotation.

dose limit: A limit on radiation dose that is applied for exposure to individuals in order to prevent the occurrence of radiation-induced deterministic effects or to limit the probability of radiation-related stochastic effects to an acceptable level.

effective dose (E): The sum of the weighted equivalent doses for the radiosensitive tissues and organs of the body. It is given by the expression:

$$E = \sum w_T H_T, \quad (G.2)$$

where H_T is the equivalent dose in tissue or organ T and w_T is the tissue weighting factor for tissue or organ T.

equivalent dose (H_T): The mean absorbed dose in a tissue or organ modified by the radiation weighting factor (w_R) for the type and energy of radiation. The equivalent dose in tissue or organ T is given by the expression:

$$H_T = \sum w_R (D_{T,R}), \quad (G.3)$$

where $D_{T,R}$ is the mean absorbed dose in the tissue or organ T due to radiation type R. The SI unit of equivalent dose is the joule per kilogram ($J kg^{-1}$) with the special name sievert (Sv). $1 Sv = 1 J kg^{-1}$.

exposure: In this Report, exposure is used most often in its general sense. When used as a defined radiation quantity, exposure is a measure of the ionization produced in air by x or gamma radiation. The unit of exposure is coulomb per kilogram ($C kg^{-1}$). The special name for exposure is roentgen (R), where $1 R = 2.58 \times 10^{-4} C kg^{-1}$. Air kerma is often used in place of exposure. An exposure of 1 R corresponds to an air kerma of 8.76 mGy (see **kerma, gray, roentgen**).

fluoroscopy: The process of producing a real-time image using x rays. The machine used for visualization, in which the dynamic image appears in real time on a display screen (usually video) is a fluoroscope. The fluoroscope can also produce a static record of an image formed on the output phosphor of an image intensifier. The image intensifier is an x-ray image receptor that increases the brightness of a fluoroscopic image by electronic amplification and image minification.

- gray (Gy):** The special name given to the SI unit of absorbed dose and kerma. $1 \text{ Gy} = 1 \text{ J kg}^{-1}$.
- half-value layer (HVL):** The thickness of a specified substance that, when introduced into the path of a given beam of ionizing radiation, reduces the air-kerma rate (or exposure rate) by one-half.
- ionization chamber:** A device for detection of ionizing radiation or for measurement of exposure, air kerma, or absorbed dose, and exposure, air-kerma, or absorbed-dose rate.
- kerma (*K*) (kinetic energy released per unit mass):** The sum of the initial kinetic energies of all the charged particles liberated by uncharged particles per unit mass of a specified material. The SI unit for kerma is J kg^{-1} , with the special name gray (Gy). $1 \text{ Gy} = 1 \text{ J kg}^{-1}$. Kerma can be quoted for any specified material at a point in free space or in an absorbing medium (*e.g.*, **air kerma**).
- kilovolt (kV):** A unit of electrical potential difference equal to 1,000 volts.
- kilovolt peak (kVp):** (also see **operating potential**). The crest value in kilovolts of the potential difference of a pulsating potential generator. When only one-half of the voltage wave cycle is used, the value refers to the useful half of the cycle.
- lead equivalence:** The thickness of lead affording the same attenuation, under specified conditions, as the material in question.
- leakage radiation:** All radiation coming from within the source assembly except for the useful beam. Leakage radiation includes the portion of the radiation coming directly from the source and not absorbed by the source assembly, as well as the scattered radiation produced within the source assembly.
- leakage radiation technique factors:** Technique factors specified for x-ray source assemblies at which leakage radiation is measured.
- milliamperere (mA):** 10^{-3} ampere. In radiography, the current flow from the cathode to the anode that, in turn, regulates the intensity of radiation emitted by the x-ray tube.
- milliamperere-minutes (mA min):** The product of the x-ray tube operating current and exposure time in minutes.
- milliamperere-seconds (mAs):** The product of the x-ray tube operating current and exposure time in seconds.
- occupancy factor (*T*):** The factor by which the workload should be multiplied to correct for the degree of occupancy (by any one person) of the area in question while the source is in the "ON" condition and emitting radiation.
- occupational exposure:** Exposures to individuals that are incurred in the workplace as a result of situations that can reasonably be regarded as being the responsibility of management (exposures associated with medical diagnosis or treatment for the individual are excluded).
- occupied area:** Any room or other space, indoors or outdoors, that is likely to be occupied by any person, either regularly or periodically during the course of the person's work, habitation or recreation and

in which an ionizing radiation field exists because of radiation sources in the vicinity.

operating potential: (also see **kilovolt peak**). The potential difference between the anode and cathode of an x-ray tube.

optically-stimulated luminescent dosimeter: A dosimeter containing a crystalline solid for measuring radiation dose, plus filters (absorbers) to help characterize the types of radiation encountered. When irradiated with intense light, optically-stimulated luminescent crystals that have been exposed to ionizing radiation give off light proportional to the energy they received from the radiation. The intense illuminating light needs to be of a different wavelength than the emitted light.

phantom: As used in this Report, for radiation protection purposes, a volume of tissue-equivalent material used to simulate the absorption and scattering characteristics of the patient's body or of a portion thereof.

pitch (*p*): In computed tomography (CT), the ratio of the patient translation per gantry rotation to the nominal beam width for the CT scan.

primary protective barrier: A barrier sufficient to attenuate the useful beam to the required degree.

primary beam (useful beam): Radiation that passes through the window, aperture, cone or other collimating device of the source housing.

primary radiation: In this Report, radiation emitted directly from the x-ray tube that is used for patient imaging.

protective barrier: A barrier of radiation attenuating material(s) used to reduce radiation exposure.

qualified expert: As used in this Report, a medical physicist or medical health physicist who is competent to design radiation shielding in medical x-ray imaging facilities. The qualified expert is a person who is certified by the American Board of Radiology, American Board of Medical Physics, American Board of Health Physics, or the Canadian College of Physicists in Medicine.

radiation protection survey: An evaluation of the radiation protection in and around an installation that includes radiation measurements, inspections, evaluations and recommendations.

radiation weighting factor (w_R): The factor by which the absorbed dose in a tissue or organ is modified to account for the type and energy of radiation in determining the probability of stochastic effects. For the x rays used in medical imaging, the radiation weighting factor is assigned the value of one.

radiography: The production of images on film or other record by the action of x rays transmitted through the patient.

roentgen (R): The special name for exposure, which is a specific quantity of ionization (charge) produced by the absorption of x- or gamma-radiation energy in a specified mass of air under standard conditions. $1 \text{ R} = 2.58 \times 10^{-4} \text{ C kg}^{-1}$ (coulombs per kilogram).

scattered radiation: Radiation that, during interaction with matter, is changed in direction, and the change is usually accompanied by a

decrease in energy. For purposes of radiation protection in medical x-ray imaging, scattered radiation is assumed to come primarily from interactions of primary radiation with tissues of the patient.

secondary protective barrier: A barrier sufficient to attenuate scattered and leakage radiations to the required degree.

secondary radiation: The sum of leakage and scattered radiations.

shielding design goals (P): Practical values, for a single medical x-ray imaging source or set of sources, that are evaluated at a reference point beyond a protective barrier. When used in conjunction with the conservatively safe assumptions recommended in this Report, the shielding design goals will ensure that the respective annual values for effective dose recommended in this Report for controlled and uncontrolled areas are not exceeded. For low linear-energy transfer radiation, the quantity air kerma is used. *P* can be expressed as a weekly or annual value (e.g., mGy week⁻¹ or mGy y⁻¹ air kerma), but is most often expressed as weekly values since the workload for a medical x-ray imaging source has traditionally utilized a weekly format.

sievert (Sv): The special name for the SI unit of equivalent dose (H_T) and effective dose (E). 1 Sv = 1 J kg⁻¹.

source: In this Report, the target (*i.e.*, the focal spot) of the x-ray tube.

target: The part of an x-ray tube anode assembly impacted by the electron beam to produce the useful x-ray beam.

tissue weighting factor (w_T): The factor by which the equivalent dose in tissue or organ T is weighted, and which represents the relative contribution of that organ or tissue to the total detriment due to stochastic effects resulting from uniform irradiation of the whole body.

uncontrolled (noncontrolled) area: Any space not meeting the definition of controlled area.

use factor (U) (beam direction factor): Fraction of the workload during which the useful beam is directed at the barrier under consideration.

workload (W): The degree of use of an x-ray source. In this Report, the workload of a medical imaging x-ray tube is the time integral of the x-ray tube current and is given in units of milliampere-minutes (mA min). The total workload per week (W_{tot}) is the total workload over a specified period and in this Report is expressed in mA min week⁻¹.

x rays: Electromagnetic radiation typically produced by high-energy electrons impinging on a metal target.

x-ray tube housing: An enclosure constructed so that leakage radiation does not exceed specified limits. In this Report, an x-ray tube housing so constructed that the leakage radiation measured at a distance of 1 m from the source cannot exceed 0.876 mGy air kerma (100 mR exposure) in 1 h when the x-ray tube is operated at its maximum continuous rated current for the maximum rated tube potential.

Symbols

α, β, γ	fitting parameters in the mathematical model for transmission of broad x-ray beams through shielding materials (Archer <i>et al.</i> , 1983)
κ	scatter fraction per centimeter, used in computed tomography
θ	scattering angle (measured from original primary beam direction)
τ	x-ray tube rotation time for a helical or spiral computed tomography scanner
a_1	scatter fraction per primary beam area at 1 m primary distance
B	broad-beam transmission
B_{housing}	transmission of leakage radiation through x-ray tube housing
B_{p}	broad-beam transmission of primary beam
B_{sec}	broad-beam transmission of secondary radiation
$CTDI_{100}$	computed tomography dose index, measured with a single axial rotation using a 100 mm long ionization chamber
d	distance from a radiation source to an occupied area
d_F	primary beam distance at which primary beam field area is F
d_L	leakage radiation distance from x-ray tube to occupied area
d_P	distance traveled by primary beam from x-ray tube to occupied area
d_S	scattered radiation distance from center of patient to occupied area
d_{sec}	secondary radiation distance derived from d_L and d_S
DLI	dose-line integral
DLP	dose-length product
E	effective dose
F	primary beam field area at primary beam distance d_F
H_T	equivalent dose to a tissue or organ
I_{max}	highest x-ray tube current that can be sustained at the maximum value of kVp
K	air kerma

K_L	air kerma in an occupied area due to leakage radiation
\dot{K}_L	leakage air-kerma rate at 1 m from source
\dot{K}_{lim}	maximum permitted leakage air-kerma rate at 1 m when x-ray tube is operated at its maximum leakage radiation technique factors for kVp and mA
K_P	air kerma in an occupied area due to primary radiation
$K_P(0)$	unshielded primary air kerma at d_p due to N patients examined per week
K_P^1	unshielded primary air kerma per patient at 1 m calculated for a workload distribution of total workload per patient W_{norm}
K_S	air kerma in an occupied area due to scattered radiation
K_{sec}	air kerma in an occupied area due to total secondary radiations
$K_{sec}(0)$	unshielded secondary air kerma at d_{sec} due to N patients examined per week
K_{sec}^1	unshielded secondary air kerma per patient at 1 m calculated for a workload distribution of total workload per patient W_{norm}
K_W^1	air kerma at 1 m per unit workload due to primary beam
kVp	x-ray tube operating potential in kilovolt peak
kVp_{max}	maximum x-ray tube operating potential (maximum kVp) at which continuous operation is possible
L	length of patient scanned (or scan length) in computed tomography examination
mAs	current-time product in milliamperere (mA) second (s)
N	number of patients per week undergoing x-ray procedures in a given x-ray room
${}_nCTDI_{100}$	$CTDI_{100}$ normalized per milliamperere second
N_R	total number of rotations in an axial or helical computed tomography scan series
p	pitch, the ratio of the patient translation per gantry rotation to the nominal beam width for a computed tomography scan
P	shielding design goal (mGy week ⁻¹ air kerma)
T	occupancy factor
T_b	nominal width of a computed tomography x-ray fan beam along the axis of rotation
U	use factor
W	x-ray tube workload (mA min)

W_{norm}	average workload per patient (mA min patient ⁻¹) (Simpkin, 1996a)
w_{R}	radiation weighting factor
W_{site}	site-specific average workload per patient at the installation under evaluation (mA min patient ⁻¹)
w_{T}	tissue weighting factor
W_{tot}	total workload per week (mA min week ⁻¹)
$x_{1/2}$	half-value layer (HVL) for an x-ray beam
x_{barrier}	thickness of barrier material that decreases air kerma in occupied area to the appropriate shielding design goal
x_{est}	estimated barrier thickness that decreases the sum of transmitted air kerma contributions to P/T ; used in the iteration method of determining the barrier thickness
x_{pre}	thickness of “preshielding” material that intercepts the primary beam
z	distance along the axis of rotation of a computed tomography scanner

References

- ARCHER, B.R., THORNBY, J.I. and BUSHONG, S.C. (1983). "Diagnostic x-ray shielding design based on an empirical model of photon attenuation," *Health Phys.* **44**(5), 507–517.
- ARCHER, B.R., FEWELL, T.R., CONWAY B.J. and QUINN, P.W. (1994). "Attenuation properties of diagnostic x-ray shielding materials," *Med. Phys.* **21**(9), 1499–1507.
- ASTM (2001). American Society for Testing and Materials. *Standard Specification for Flat Glass*, C1036-01 (American Society for Testing and Materials, West Conshohocken, Pennsylvania).
- ASTM (2003a). American Society for Testing and Materials. *Standard Specification for Lead Products*, B 749-03 (American Society for Testing and Materials, West Conshohocken, Pennsylvania).
- ASTM (2003b). American Society for Testing and Materials. *Standard Specification for Gypsum Wallboard*, C36/C36M-03 (American Society for Testing and Materials, West Conshohocken, Pennsylvania).
- AVALLONE, E. and BAUMEISTER, T. (1996). *Mark's Standard Handbook for Mechanical Engineers*, 10th ed. (McGraw-Hill, New York).
- AWI (2003). Architectural Woodwork Institute. *Quality Standards Illustrated*, 8th ed. (Architectural Woodwork Institute, Reston, Virginia).
- DIXON, R.L. (1994). "On the primary barrier in diagnostic x-ray shielding," *Med. Phys.* **21**(11), 1785–1793.
- DIXON, R.L. (2003). "A new look at CT dose measurement: Beyond CTDI," *Med. Phys.* **30**(6), 1272–1280.
- DIXON, R.L. and SIMPKIN, D.J. (1998). "Primary shielding barriers for diagnostic x-ray facilities: A new model," *Health Phys.* **74**(2), 181–189.
- EC (1999). European Commission. *European Guidelines on Quality Criteria for Computed Tomography*, Report EUR 16262 (European Commission, Luxembourg).
- FDA (2003a). Food and Drug Administration. "21 CFR 1020.30(k)—Performance standards for ionizing radiation emitting products. Diagnostic x-ray systems and their major components. Leakage radiation from the diagnostic source assembly" (revised April 1) (U.S. Government Printing Office, Washington) [<http://www.gpoaccess.gov/cfr/index.html> (accessed May 7, 2004)].
- FDA (2003b). Food and Drug Administration. "21 CFR 1020.31(m)—Performance standards for ionizing radiation emitting products. Primary protective barrier for mammography x-ray systems" (revised April 1) (U.S. Government Printing Office, Washington) [<http://www.gpoaccess.gov/cfr/index.html> (accessed May 7, 2004)].

- FDA (2003c). Food and Drug Administration. "21 CFR 1020.32(a)—Performance standards for ionizing radiation emitting products. Fluoroscopy equipment. Primary protection barrier" (revised April 1) (U.S. Government Printing Office, Washington) [<http://www.gpoaccess.gov/cfr/index.html> (accessed May 7, 2004)].
- FDA (2003d). Food and Drug Administration. "21 CFR 1020.33(b)(1) and (b)(6)—Performance standards for ionizing radiation emitting products. Computed tomography (CT) equipment. Definitions. Computer topography dose index (CTDI), and CT dosimetry phantom" (revised April 1) (U.S. Government Printing Office, Washington) [<http://www.gpoaccess.gov/cfr/index.html> (accessed May 7, 2004)].
- GLAZE, S.A., SCHNEIDERS, N.J. and BUSHONG, S.C. (1979). "Use of gypsum wallboard for diagnostic x-ray protective barriers," *Health Phys.* **36**, 587–593.
- ICRP (1991). International Commission on Radiological Protection. *1990 Recommendations of the International Commission on Radiological Protection*, ICRP Publication 60, *Annals of the ICRP* **21**(1-3) (Elsevier Science, New York).
- ICRP (1996). International Commission on Radiological Protection. *Conversion Coefficients for Use in Radiological Protection Against External Radiation*, ICRP Publication 74, *Annals of the ICRP* **26**(3/4) (Elsevier Science, New York).
- ICRU (1998a). International Commission on Radiation Units and Measurements. *Fundamental Quantities and Units for Ionizing Radiation*, ICRU Report 60 (International Commission on Radiation Units and Measurements, Bethesda, Maryland).
- ICRU (1998b). International Commission on Radiation Units and Measurements. *Conversion Coefficients for Use in Radiological Protection Against External Radiation*, ICRU Report 57 (International Commission on Radiation Units and Measurements, Bethesda, Maryland).
- IEC (2002). International Electrotechnical Commission. *Medical Electrical Equipment: Particular Requirements for the Safety of X-Ray Equipment for Computed Tomography*, 2nd ed., 1st amendment IEC 60601-2-44 (American National Standards Institute, New York).
- IMPACT (2004). Imaging Performance Assessment of Computed Tomography Scanners. *Updated CTDI Tables*, <http://www.impactscan.org/ctditables.htm> (accessed August 2004) (Imaging Performance Assessment of Computed Tomography, St. George's Hospital, Tooting, London).
- LANGER, S.G. and GRAY, J.E. (1988). "Radiation shielding implications of computed tomography scatter exposure to the floor," *Health Phys.* **75**, 193–196.
- LEGARE, J.M., CARRIERES, P.E., MANSEAU, A., BIBEAU, C., ROBERT, J. and ROBIDOUX, N. (1978). "Blindage contre les grands champs de rayons X primaires et diffuses des appareils triphases au moyen de panneaux de verre, de gypse et de plomb acoustique," *Radio Protection* **13**, 79–95.

- MCCOLLOUGH, C.H. and ZINK, F.E. (1999). "Performance evaluation of a multi-slice CT system," *Med. Phys.* **26**(11), 2223–2230.
- MCNITT-GRAY, M.F. (2002). "AAPM/RSNA physics tutorial for residents: Topics in CT. Radiation dose in CT," *Radiographics* **22**(6), 1541–1553.
- NAGEL, H.D., Ed. (2002). *Radiation Exposure in Computed Tomography*, 4th ed., D-21073 (CTB Publications, Hamburg).
- NCRP (1970). National Council on Radiation Protection and Measurements. *Radiation Protection in Veterinary Medicine*, NCRP Report No. 36 (National Council on Radiation Protection and Measurements, Bethesda, Maryland).
- NCRP (1976). National Council on Radiation Protection and Measurements. *Structural Shielding Design and Evaluation for Medical Use of X Rays and Gamma Rays of Energies Up to 10 MeV*, NCRP Report No. 49 (National Council on Radiation Protection and Measurements, Bethesda, Maryland).
- NCRP (1985). National Council on Radiation Protection and Measurements. *SI Units in Radiation Protection and Measurements*, NCRP Report No. 82 (National Council on Radiation in Protection and Measurements, Bethesda, Maryland).
- NCRP (1986). National Council on Radiation Protection and Measurements. *Mammography A User's Guide*, NCRP Report No. 85 (National Council on Radiation Protection and Measurements, Bethesda, Maryland).
- NCRP (1990). National Council on Radiation Protection and Measurements. *Implementation of the Principle of As Low As Reasonably Achievable (ALARA) for Medical and Dental Personnel*, NCRP Report No. 107 (National Council on Radiation Protection and Measurements, Bethesda, Maryland).
- NCRP (1993). National Council on Radiation Protection and Measurements. *Limitation of Exposure to Ionizing Radiation*, NCRP Report No. 116 (National Council on Radiation Protection and Measurements, Bethesda, Maryland).
- NCRP (2000). National Council on Radiation Protection and Measurements. *Radiation Protection for Procedures Performed Outside the Radiology Department*, NCRP Report No. 133 (National Council on Radiation Protection and Measurements, Bethesda, Maryland).
- NCRP (2003). National Council on Radiation Protection and Measurements. *Radiation Protection in Dentistry*, NCRP Report No. 145 (National Council on Radiation Protection and Measurements, Bethesda, Maryland).
- NCRP (in press). National Council on Radiation Protection and Measurements. *Radiation Protection in Veterinary Medicine*, NCRP Report No. 148 (National Council on Radiation Protection and Measurements, Bethesda, Maryland).
- PATEL, R., BLAKE, G.M., BATCHELOR, S. and FOGELMAN, I. (1996). "Occupational dose to the radiographer in dual x-ray absorptiometry:

- A comparison of pencil-beam and fan-beam systems," Br. J. Radiol. **69**(822), 539–543.
- ROECK, W.W. (1994). "X-ray room preparation: Layout and design considerations," in *Specification, Acceptance Testing and Quality Control of Diagnostic X-Ray Imaging Equipment*, American Association of Physicists in Medicine Medical Physics Monograph No. 20 (American Institute of Physics, Melville, New York).
- SDI (2003). Steel Door Institute. *Recommended Specifications for Standard Steel Doors and Frames*, SDI 100, ANSI/SDI-A250.8 (Steel Door Institute, Cleveland, Ohio).
- SHOPE, T.B., GAGNE, R.M. and JOHNSON, G.C. (1981). "A method for describing the doses delivered by transmission x-ray computed tomography," Med. Phys. **8**(4), 488–495.
- SIMPKIN, D.J. (1987a). "Shielding requirements for mammography," Health Phys. **53**(3), 267–279.
- SIMPKIN, D.J. (1987b). "A general solution to the shielding of medical x and γ rays by the NCRP Report No. 49 methods," Health Phys. **52**(4), 431–436.
- SIMPKIN, D.J. (1991). "Shielding a spectrum of workloads in diagnostic radiology," Health Phys. **61**(2), 259–261.
- SIMPKIN, D.J. (1995). "Transmission data for shielding diagnostic x-ray facilities," Health Phys. **68**(5), 704–709.
- SIMPKIN, D.J. (1996a). "Evaluation of NCRP Report No. 49 assumptions on workloads and use factors in diagnostic radiology facilities," Med. Phys. **23**(4), 577–584.
- SIMPKIN, D.J. (1996b). "Scatter radiation intensities about mammographic units," Health Phys. **70**(2), 238–244.
- SIMPKIN, D.J. and DIXON, R.L. (1998). "Secondary shielding barriers for diagnostic x-ray facilities: Scatter and leakage revisited," Health Phys. **74**(3), 350–365.
- SULEIMAN, O.H., CONWAY, B.J., FEWELL, T.R., SLAYTON, R.J., RUETER, F.G. and GRAY, J. (1995). "Radiation protection requirements for medical x-ray film," Med. Phys. **22**(10), 1691–1693.
- SUTTON, D.G. and WILLIAMS, J.R., Eds. (2000). *Radiation Shielding for Diagnostic X-Rays* (British Institute of Radiology, London).
- TROUT, E.D. and KELLY, J.P. (1972). "Scattered radiation from a tissue-equivalent phantom for x rays from 50 to 300 kVp," Radiology **104**(1), 161–169.

The NCRP

The National Council on Radiation Protection and Measurements is a nonprofit corporation chartered by Congress in 1964 to:

1. Collect, analyze, develop and disseminate in the public interest information and recommendations about (a) protection against radiation and (b) radiation measurements, quantities and units, particularly those concerned with radiation protection.
2. Provide a means by which organizations concerned with the scientific and related aspects of radiation protection and of radiation quantities, units and measurements may cooperate for effective utilization of their combined resources, and to stimulate the work of such organizations.
3. Develop basic concepts about radiation quantities, units and measurements, about the application of these concepts, and about radiation protection.
4. Cooperate with the International Commission on Radiological Protection, the International Commission on Radiation Units and Measurements, and other national and international organizations, governmental and private, concerned with radiation quantities, units and measurements and with radiation protection.

The Council is the successor to the unincorporated association of scientists known as the National Committee on Radiation Protection and Measurements and was formed to carry on the work begun by the Committee in 1929.

The participants in the Council's work are the Council members and members of scientific and administrative committees. Council members are selected solely on the basis of their scientific expertise and serve as individuals, not as representatives of any particular organization. The scientific committees, composed of experts having detailed knowledge and competence in the particular area of the committee's interest, draft proposed recommendations. These are then submitted to the full membership of the Council for careful review and approval before being published.

The following comprise the current officers and membership of the Council:

Officers

<i>President</i>	Thomas S. Tenforde
<i>Senior Vice President</i>	Kenneth R. Kase
<i>Secretary and Treasurer</i>	David A. Schauer
<i>Assistant Secretary</i>	Michael F. McBride

Members

John F. Ahearne	Donald P. Frush	David S. Myers
Sally A. Amundson	Thomas F. Gesell	Bruce A. Napier
Larry E. Anderson	Ethel S. Gilbert	Carl J. Paperiello
Benjamin R. Archer	Joel E. Gray	Ronald C. Petersen
Mary M. Austin-Seymour	Andrew J. Grosovsky	R. Julian Preston
Joel S. Bedford	Raymond A. Guilmette	Jerome S. Puskin
Eleanor A. Blakely	Roger W. Harms	Allan C.B. Richardson
William F. Blakely	John W. Hirshfeld, Jr.	Henry D. Royal
John D. Boice, Jr.	F. Owen Hoffman	Marvin Rosenstein
Thomas B. Borak	Roger W. Howell	Michael T. Ryan
Andre Bouville	Kenneth R. Kase	Jonathan M. Samet
Leslie A. Braby	Ann R. Kennedy	Stephen M. Seltzer
David J. Brenner	William E. Kennedy, Jr.	Roy E. Shore
Antone L. Brooks	David C. Kocher	Edward A. Sickles
Jerrold T. Bushberg	Ritsuko Komaki	Steven L. Simon
John F. Cardella	Amy Kronenberg	Paul Slovic
Stephanie K. Carlson	Charles E. Land	Daniel J. Strom
S.Y. Chen	Susan M. Langhorst	Thomas S. Tenforde
Kelly L. Classic	Howard L. Liber	Julie E.K. Timins
Mary E. Clark	James C. Lin	Lawrence W. Townsend
James E. Cleaver	Jill A. Lipoti	Lois B. Travis
Michael L. Corradini	John B. Little	Robert L. Ullrich
J. Donald Cossairt	Paul A. Locke	Richard J. Vetter
Allen G. Croff	Jay H. Lubin	Daniel E. Wartenberg
Francis A. Cucinotta	C. Douglas Maynard	David A. Weber
Carter Denniston	Claire M. Mays	Chris G. Whipple
Paul M. DeLuca	Cynthia H. McCollough	Stuart C. White
John F. Dicello, Jr.	Barbara J. McNeil	J. Frank Wilson
William P. Dornsife	Fred A. Mettler, Jr.	Susan D. Wiltshire
David A. Eastmond	Charles W. Miller	Gayle E. Woloschak
Stephen A. Feig	Jack Miller	Marco A. Zaidar
Kenneth R. Foster	Kenneth L. Miller	Pasquale D. Zanzonico
John R. Frazier	William F. Morgan	Marvin C. Ziskin
	John E. Moulder	

*Honorary Members*Lauriston S. Taylor, *Honorary President*Warren K. Sinclair, *President Emeritus*; Charles B. Meinhold, *President Emeritus*S. James Adelstein, *Honorary Vice President*W. Roger Ney, *Executive Director Emeritus*William M. Beckner, *Executive Director Emeritus*

Seymour Abrahamson	Sarah S. Donaldson	A. Alan Moghissi
Edward L. Alpen	Patricia W. Durbin	Wesley L. Nyborg
Lynn R. Anspaugh	Keith F. Eckerman	John W. Poston, Sr.
John A. Auxier	Thomas S. Ely	Andrew K. Poznanski
William J. Bair	Richard F. Foster	Chester R. Richmond
Harold L. Beck	R.J. Michael Fry	Genevieve S. Roessler
Bruce B. Boecker	Robert O. Gorson	Lawrence N. Rothenberg
Victor P. Bond	Arthur W. Guy	Eugene L. Saenger
Robert L. Brent	Eric J. Hall	William J. Schull
Reynold F. Brown	Naomi H. Harley	J. Newell Stannard
Melvin C. Carter	William R. Hendee	John B. Storer
Randall S. Caswell	Donald G. Jacobs	John E. Till
Frederick P. Cowan	Bernd Kahn	Arthur C. Upton
James F. Crow	Roger O. McClellan	Edward W. Webster
Gerald D. Dodd	Dade W. Moeller	F. Ward Whicker

Lauriston S. Taylor Lecturers

- Abel J. Gonzalez (2004) *Radiation Protection in the Aftermath of a Terrorist Attack Involving Exposure to Ionizing Radiation*
- Charles B. Meinhold (2003) *The Evolution of Radiation Protection: From Erythema to Genetic Risks to Risks of Cancer to ?*
- R. Julian Preston (2002) *Developing Mechanistic Data for Incorporation into Cancer Risk Assessment: Old Problems and New Approaches*
- Wesley L. Nyborg (2001) *Assuring the Safety of Medical Diagnostic Ultrasound*
- S. James Adelstein (2000) *Administered Radioactivity: Unde Venimus Quoque Imus*
- Naomi H. Harley (1999) *Back to Background*
- Eric J. Hall (1998) *From Chimney Sweeps to Astronauts: Cancer Risks in the Workplace*
- William J. Bair (1997) *Radionuclides in the Body: Meeting the Challenge!*
- Seymour Abrahamson (1996) *70 Years of Radiation Genetics: Fruit Flies, Mice and Humans*
- Albrecht Kellerer (1995) *Certainty and Uncertainty in Radiation Protection*
- R.J. Michael Fry (1994) *Mice, Myths and Men*
- Warren K. Sinclair (1993) *Science, Radiation Protection and the NCRP*
- Edward W. Webster (1992) *Dose and Risk in Diagnostic Radiology: How Big? How Little?*
- Victor P. Bond (1991) *When is a Dose Not a Dose?*
- J. Newell Stannard (1990) *Radiation Protection and the Internal Emitter Saga*
- Arthur C. Upton (1989) *Radiobiology and Radiation Protection: The Past Century and Prospects for the Future*
- Bo Lindell (1988) *How Safe is Safe Enough?*
- Seymour Jablon (1987) *How to be Quantitative about Radiation Risk Estimates*
- Herman P. Schwan (1986) *Biological Effects of Non-ionizing Radiations: Cellular Properties and Interactions*
- John H. Harley (1985) *Truth (and Beauty) in Radiation Measurement*
- Harald H. Rossi (1984) *Limitation and Assessment in Radiation Protection*
- Merril Eisenbud (1983) *The Human Environment—Past, Present and Future*
- Eugene L. Saenger (1982) *Ethics, Trade-Offs and Medical Radiation*
- James F. Crow (1981) *How Well Can We Assess Genetic Risk? Not Very*
- Harold O. Wyckoff (1980) *From "Quantity of Radiation" and "Dose" to "Exposure" and "Absorbed Dose"—An Historical Review*
- Hymer L. Friedell (1979) *Radiation Protection—Concepts and Trade Offs*
- Sir Edward Pochin (1978) *Why be Quantitative about Radiation Risk Estimates?*
- Herbert M. Parker (1977) *The Squares of the Natural Numbers in Radiation Protection*

Currently, the following committees are actively engaged in formulating recommendations:

Program Area Committee 1: Basic Criteria, Epidemiology, Radiobiology, and Risk

- SC 1-4 Extrapolation of Risks from Nonhuman Experimental Systems to Man
- SC 1-7 Information Needed to Make Radiation Protection Recommendations for Travel Beyond Low-Earth Orbit
- SC 1-8 Risk to Thyroid from Ionizing Radiation
- SC 1-13 Effects of Therapeutic Medical Treatment and Genetic Background
- SC 1-14 Public Dose Limits for Ionizing Radiation
- SC 57-15 Uranium Risks
- SC 85 Risk of Lung Cancer from Radon

Program Area Committee 2: Operational Radiation Safety

- SC 46-13 Design of Facilities for Medical Radiation Therapy
- SC 46-16 Radiation Protection in Veterinary Medicine
- SC 46-17 Radiation Protection in Educational Institutions

Program Area Committee 3: Nonionizing Radiation

- SC 89-3 Biological Effects of Extremely Low-Frequency Electric and Magnetic Fields
- SC 89-5 Study and Critical Evaluation of Radiofrequency Exposure Guidelines

Program Area Committee 4: Radiation Protection in Medicine

- SC 72 Radiation Protection in Mammography
- SC 91-1 Precautions in the Management of Patients Who Have Received Therapeutic Amounts of Radionuclides

Program Area Committee 5: Environmental Radiation and Radioactive Waste Issues

- SC 64-22 Design of Effective Effluent and Environmental Monitoring Programs
- SC 64-23 Cesium in the Environment
- SC 87-3 Performance Assessment of Near Surface Radioactive Waste Facilities

Program Area Committee 6: Radiation Measurements and Dosimetry

- SC 57-17 Radionuclide Dosimetry Models for Wounds
- SC 6-1 Uncertainties in the Measurement and Dosimetry of External Radiation Sources

Advisory Committee 1: Public Policy and Risk Communication

In recognition of its responsibility to facilitate and stimulate cooperation among organizations concerned with the scientific and related aspects of radiation protection and measurement, the Council has created a category of NCRP Collaborating Organizations. Organizations or groups of organizations that are national or international in scope and are concerned

with scientific problems involving radiation quantities, units, measurements and effects, or radiation protection may be admitted to collaborating status by the Council. Collaborating Organizations provide a means by which the NCRP can gain input into its activities from a wider segment of society. At the same time, the relationships with the Collaborating Organizations facilitate wider dissemination of information about the Council's activities, interests and concerns. Collaborating Organizations have the opportunity to comment on draft reports (at the time that these are submitted to the members of the Council). This is intended to capitalize on the fact that Collaborating Organizations are in an excellent position to both contribute to the identification of what needs to be treated in NCRP reports and to identify problems that might result from proposed recommendations. The present Collaborating Organizations with which the NCRP maintains liaison are as follows:

- American Academy of Dermatology
- American Academy of Environmental Engineers
- American Academy of Health Physics
- American Association of Physicists in Medicine
- American College of Medical Physics
- American College of Nuclear Physicians
- American College of Occupational and Environmental Medicine
- American College of Radiology
- American Dental Association
- American Industrial Hygiene Association
- American Institute of Ultrasound in Medicine
- American Medical Association
- American Nuclear Society
- American Pharmaceutical Association
- American Podiatric Medical Association
- American Public Health Association
- American Radium Society
- American Roentgen Ray Society
- American Society for Therapeutic Radiology and Oncology
- American Society of Emergency Radiology
- American Society of Health-System Pharmacists
- American Society of Radiologic Technologists
- Association of Educators in Radiological Sciences, Inc.
- Association of University Radiologists
- Bioelectromagnetics Society
- Campus Radiation Safety Officers
- College of American Pathologists
- Conference of Radiation Control Program Directors, Inc.
- Council on Radionuclides and Radiopharmaceuticals
- Defense Threat Reduction Agency
- Electric Power Research Institute
- Federal Communications Commission
- Federal Emergency Management Agency

Genetics Society of America
 Health Physics Society
 Institute of Electrical and Electronics Engineers, Inc.
 Institute of Nuclear Power Operations
 International Brotherhood of Electrical Workers
 National Aeronautics and Space Administration
 National Association of Environmental Professionals
 National Center for Environmental Health/Agency for
 Toxic Substances
 National Electrical Manufacturers Association
 National Institute for Occupational Safety and Health
 National Institute of Standards and Technology
 Nuclear Energy Institute
 Office of Science and Technology Policy
 Paper, Allied-Industrial, Chemical and Energy Workers
 International Union
 Product Stewardship Institute
 Radiation Research Society
 Radiological Society of North America
 Society for Risk Analysis
 Society of Chairmen of Academic Radiology Departments
 Society of Nuclear Medicine
 Society of Radiologists in Ultrasound
 Society of Skeletal Radiology
 U.S. Air Force
 U.S. Army
 U.S. Coast Guard
 U.S. Department of Energy
 U.S. Department of Housing and Urban Development
 U.S. Department of Labor
 U.S. Department of Transportation
 U.S. Environmental Protection Agency
 U.S. Navy
 U.S. Nuclear Regulatory Commission
 U.S. Public Health Service
 Utility Workers Union of America

The NCRP has found its relationships with these organizations to be extremely valuable to continued progress in its program.

Another aspect of the cooperative efforts of the NCRP relates to the Special Liaison relationships established with various governmental organizations that have an interest in radiation protection and measurements. This liaison relationship provides: (1) an opportunity for participating organizations to designate an individual to provide liaison between the organization and the NCRP; (2) that the individual designated will receive copies of draft NCRP reports (at the time that these are submitted to the members of the Council) with an invitation to comment, but not vote; and (3) that new NCRP efforts might be discussed with liaison individuals as

appropriate, so that they might have an opportunity to make suggestions on new studies and related matters. The following organizations participate in the Special Liaison Program:

Australian Radiation Laboratory
Bundesamt für Strahlenschutz (Germany)
Canadian Nuclear Safety Commission
Central Laboratory for Radiological Protection (Poland)
China Institute for Radiation Protection
Commonwealth Scientific Instrumentation Research
Organization (Australia)
European Commission
Health Council of the Netherlands
Institut de Radioprotection et de Sûreté Nucleaire
International Commission on Non-ionizing Radiation Protection
International Commission on Radiation Units and Measurements
Japan Radiation Council
Korea Institute of Nuclear Safety
National Radiological Protection Board (United Kingdom)
Russian Scientific Commission on Radiation Protection
South African Forum for Radiation Protection
World Association of Nuclear Operations
World Health Organization, Radiation and Environmental Health

The NCRP values highly the participation of these organizations in the Special Liaison Program.

The Council also benefits significantly from the relationships established pursuant to the Corporate Sponsor's Program. The program facilitates the interchange of information and ideas and corporate sponsors provide valuable fiscal support for the Council's program. This developing program currently includes the following Corporate Sponsors:

3M Corporate Health Physics
Amersham Health
Duke Energy Corporation
Global Dosimetry Solutions
Landauer, Inc.
Nuclear Energy Institute
Philips Medical Systems
Southern California Edison Company

The Council's activities have been made possible by the voluntary contribution of time and effort by its members and participants and the generous support of the following organizations:

3M Health Physics Services
Agfa Corporation
Alfred P. Sloan Foundation

Alliance of American Insurers
American Academy of Dermatology
American Academy of Health Physics
American Academy of Oral and Maxillofacial Radiology
American Association of Physicists in Medicine
American Cancer Society
American College of Medical Physics
American College of Nuclear Physicians
American College of Occupational and Environmental Medicine
American College of Radiology
American College of Radiology Foundation
American Dental Association
American Healthcare Radiology Administrators
American Industrial Hygiene Association
American Insurance Services Group
American Medical Association
American Nuclear Society
American Osteopathic College of Radiology
American Podiatric Medical Association
American Public Health Association
American Radium Society
American Roentgen Ray Society
American Society of Radiologic Technologists
American Society for Therapeutic Radiology and Oncology
American Veterinary Medical Association
American Veterinary Radiology Society
Association of Educators in Radiological Sciences, Inc.
Association of University Radiologists
Battelle Memorial Institute
Canberra Industries, Inc.
Chem Nuclear Systems
Center for Devices and Radiological Health
College of American Pathologists
Committee on Interagency Radiation Research
and Policy Coordination
Commonwealth Edison
Commonwealth of Pennsylvania
Consolidated Edison
Consumers Power Company
Council on Radionuclides and Radiopharmaceuticals
Defense Nuclear Agency
Defense Threat Reduction Agency
Eastman Kodak Company
Edison Electric Institute
Edward Mallinckrodt, Jr. Foundation
EG&G Idaho, Inc.
Electric Power Research Institute

Electromagnetic Energy Association
Federal Emergency Management Agency
Florida Institute of Phosphate Research
Florida Power Corporation
Fuji Medical Systems, U.S.A., Inc.
Genetics Society of America
Global Dosimetry Solutions
Health Effects Research Foundation (Japan)
Health Physics Society
ICN Biomedicals, Inc.
Institute of Nuclear Power Operations
James Picker Foundation
Martin Marietta Corporation
Motorola Foundation
National Aeronautics and Space Administration
National Association of Photographic Manufacturers
National Cancer Institute
National Electrical Manufacturers Association
National Institute of Standards and Technology
New York Power Authority
Picker International
Public Service Electric and Gas Company
Radiation Research Society
Radiological Society of North America
Richard Lounsbery Foundation
Sandia National Laboratory
Siemens Medical Systems, Inc.
Society of Nuclear Medicine
Society of Pediatric Radiology
U.S. Department of Energy
U.S. Department of Labor
U.S. Environmental Protection Agency
U.S. Navy
U.S. Nuclear Regulatory Commission
Victoreen, Inc.
Westinghouse Electric Corporation

Initial funds for publication of NCRP reports were provided by a grant from the James Picker Foundation.

NCRP seeks to promulgate information and recommendations based on leading scientific judgment on matters of radiation protection and measurement and to foster cooperation among organizations concerned with these matters. These efforts are intended to serve the public interest and the Council welcomes comments and suggestions on its reports or activities.

NCRP Publications

Information on NCRP publications may be obtained from the NCRP website (<http://www.ncrponline.org>) or by telephone (800-229-2652, ext. 25) and fax (301-907-8768). The address is:

NCRP Publications
7910 Woodmont Avenue
Suite 400
Bethesda, MD 20814-3095

Abstracts of NCRP reports published since 1980, abstracts of all NCRP commentaries, and the text of all NCRP statements are available at the NCRP website. Currently available publications are listed below.

NCRP Reports

No.	Title
8	<i>Control and Removal of Radioactive Contamination in Laboratories</i> (1951)
22	<i>Maximum Permissible Body Burdens and Maximum Permissible Concentrations of Radionuclides in Air and in Water for Occupational Exposure</i> (1959) [includes Addendum 1 issued in August 1963]
25	<i>Measurement of Absorbed Dose of Neutrons, and of Mixtures of Neutrons and Gamma Rays</i> (1961)
27	<i>Stopping Powers for Use with Cavity Chambers</i> (1961)
30	<i>Safe Handling of Radioactive Materials</i> (1964)
32	<i>Radiation Protection in Educational Institutions</i> (1966)
35	<i>Dental X-Ray Protection</i> (1970)
36	<i>Radiation Protection in Veterinary Medicine</i> (1970)
37	<i>Precautions in the Management of Patients Who Have Received Therapeutic Amounts of Radionuclides</i> (1970)
38	<i>Protection Against Neutron Radiation</i> (1971)
40	<i>Protection Against Radiation from Brachytherapy Sources</i> (1972)
41	<i>Specification of Gamma-Ray Brachytherapy Sources</i> (1974)

- 42 *Radiological Factors Affecting Decision-Making in a Nuclear Attack* (1974)
- 44 *Krypton-85 in the Atmosphere—Accumulation, Biological Significance, and Control Technology* (1975)
- 46 *Alpha-Emitting Particles in Lungs* (1975)
- 47 *Tritium Measurement Techniques* (1976)
- 49 *Structural Shielding Design and Evaluation for Medical Use of X Rays and Gamma Rays of Energies Up to 10 MeV* (1976)
- 50 *Environmental Radiation Measurements* (1976)
- 52 *Cesium-137 from the Environment to Man: Metabolism and Dose* (1977)
- 54 *Medical Radiation Exposure of Pregnant and Potentially Pregnant Women* (1977)
- 55 *Protection of the Thyroid Gland in the Event of Releases of Radioiodine* (1977)
- 57 *Instrumentation and Monitoring Methods for Radiation Protection* (1978)
- 58 *A Handbook of Radioactivity Measurements Procedures*, 2nd ed. (1985)
- 60 *Physical, Chemical, and Biological Properties of Radiocerium Relevant to Radiation Protection Guidelines* (1978)
- 61 *Radiation Safety Training Criteria for Industrial Radiography* (1978)
- 62 *Tritium in the Environment* (1979)
- 63 *Tritium and Other Radionuclide Labeled Organic Compounds Incorporated in Genetic Material* (1979)
- 64 *Influence of Dose and Its Distribution in Time on Dose-Response Relationships for Low-LET Radiations* (1980)
- 65 *Management of Persons Accidentally Contaminated with Radionuclides* (1980)
- 67 *Radiofrequency Electromagnetic Fields—Properties, Quantities and Units, Biophysical Interaction, and Measurements* (1981)
- 68 *Radiation Protection in Pediatric Radiology* (1981)
- 69 *Dosimetry of X-Ray and Gamma-Ray Beams for Radiation Therapy in the Energy Range 10 keV to 50 MeV* (1981)
- 70 *Nuclear Medicine—Factors Influencing the Choice and Use of Radionuclides in Diagnosis and Therapy* (1982)
- 72 *Radiation Protection and Measurement for Low-Voltage Neutron Generators* (1983)
- 73 *Protection in Nuclear Medicine and Ultrasound Diagnostic Procedures in Children* (1983)
- 74 *Biological Effects of Ultrasound: Mechanisms and Clinical Implications* (1983)
- 75 *Iodine-129: Evaluation of Releases from Nuclear Power Generation* (1983)
- 77 *Exposures from the Uranium Series with Emphasis on Radon and Its Daughters* (1984)

- 78 *Evaluation of Occupational and Environmental Exposures to Radon and Radon Daughters in the United States* (1984)
- 79 *Neutron Contamination from Medical Electron Accelerators* (1984)
- 80 *Induction of Thyroid Cancer by Ionizing Radiation* (1985)
- 81 *Carbon-14 in the Environment* (1985)
- 82 *SI Units in Radiation Protection and Measurements* (1985)
- 83 *The Experimental Basis for Absorbed-Dose Calculations in Medical Uses of Radionuclides* (1985)
- 84 *General Concepts for the Dosimetry of Internally Deposited Radionuclides* (1985)
- 85 *Mammography—A User's Guide* (1986)
- 86 *Biological Effects and Exposure Criteria for Radiofrequency Electromagnetic Fields* (1986)
- 87 *Use of Bioassay Procedures for Assessment of Internal Radionuclide Deposition* (1987)
- 88 *Radiation Alarms and Access Control Systems* (1986)
- 89 *Genetic Effects from Internally Deposited Radionuclides* (1987)
- 90 *Neptunium: Radiation Protection Guidelines* (1988)
- 92 *Public Radiation Exposure from Nuclear Power Generation in the United States* (1987)
- 93 *Ionizing Radiation Exposure of the Population of the United States* (1987)
- 94 *Exposure of the Population in the United States and Canada from Natural Background Radiation* (1987)
- 95 *Radiation Exposure of the U.S. Population from Consumer Products and Miscellaneous Sources* (1987)
- 96 *Comparative Carcinogenicity of Ionizing Radiation and Chemicals* (1989)
- 97 *Measurement of Radon and Radon Daughters in Air* (1988)
- 99 *Quality Assurance for Diagnostic Imaging* (1988)
- 100 *Exposure of the U.S. Population from Diagnostic Medical Radiation* (1989)
- 101 *Exposure of the U.S. Population from Occupational Radiation* (1989)
- 102 *Medical X-Ray, Electron Beam and Gamma-Ray Protection for Energies Up to 50 MeV (Equipment Design, Performance and Use)* (1989)
- 103 *Control of Radon in Houses* (1989)
- 104 *The Relative Biological Effectiveness of Radiations of Different Quality* (1990)
- 105 *Radiation Protection for Medical and Allied Health Personnel* (1989)
- 106 *Limit for Exposure to "Hot Particles" on the Skin* (1989)
- 107 *Implementation of the Principle of As Low As Reasonably Achievable (ALARA) for Medical and Dental Personnel* (1990)

- 108 *Conceptual Basis for Calculations of Absorbed-Dose Distributions* (1991)
- 109 *Effects of Ionizing Radiation on Aquatic Organisms* (1991)
- 110 *Some Aspects of Strontium Radiobiology* (1991)
- 111 *Developing Radiation Emergency Plans for Academic, Medical or Industrial Facilities* (1991)
- 112 *Calibration of Survey Instruments Used in Radiation Protection for the Assessment of Ionizing Radiation Fields and Radioactive Surface Contamination* (1991)
- 113 *Exposure Criteria for Medical Diagnostic Ultrasound: I. Criteria Based on Thermal Mechanisms* (1992)
- 114 *Maintaining Radiation Protection Records* (1992)
- 115 *Risk Estimates for Radiation Protection* (1993)
- 116 *Limitation of Exposure to Ionizing Radiation* (1993)
- 117 *Research Needs for Radiation Protection* (1993)
- 118 *Radiation Protection in the Mineral Extraction Industry* (1993)
- 119 *A Practical Guide to the Determination of Human Exposure to Radiofrequency Fields* (1993)
- 120 *Dose Control at Nuclear Power Plants* (1994)
- 121 *Principles and Application of Collective Dose in Radiation Protection* (1995)
- 122 *Use of Personal Monitors to Estimate Effective Dose Equivalent and Effective Dose to Workers for External Exposure to Low-LET Radiation* (1995)
- 123 *Screening Models for Releases of Radionuclides to Atmosphere, Surface Water, and Ground* (1996)
- 124 *Sources and Magnitude of Occupational and Public Exposures from Nuclear Medicine Procedures* (1996)
- 125 *Deposition, Retention and Dosimetry of Inhaled Radioactive Substances* (1997)
- 126 *Uncertainties in Fatal Cancer Risk Estimates Used in Radiation Protection* (1997)
- 127 *Operational Radiation Safety Program* (1998)
- 128 *Radionuclide Exposure of the Embryo/Fetus* (1998)
- 129 *Recommended Screening Limits for Contaminated Surface Soil and Review of Factors Relevant to Site-Specific Studies* (1999)
- 130 *Biological Effects and Exposure Limits for "Hot Particles"* (1999)
- 131 *Scientific Basis for Evaluating the Risks to Populations from Space Applications of Plutonium* (2001)
- 132 *Radiation Protection Guidance for Activities in Low-Earth Orbit* (2000)
- 133 *Radiation Protection for Procedures Performed Outside the Radiology Department* (2000)
- 134 *Operational Radiation Safety Training* (2000)
- 135 *Liver Cancer Risk from Internally-Deposited Radionuclides* (2001)
- 136 *Evaluation of the Linear-Nonthreshold Dose-Response Model for Ionizing Radiation* (2001)

- 137 *Fluence-Based and Microdosimetric Event-Based Methods for Radiation Protection in Space* (2001)
- 138 *Management of Terrorist Events Involving Radioactive Material* (2001)
- 139 *Risk-Based Classification of Radioactive and Hazardous Chemical Wastes* (2002)
- 140 *Exposure Criteria for Medical Diagnostic Ultrasound: II. Criteria Based on all Known Mechanisms* (2002)
- 141 *Managing Potentially Radioactive Scrap Metal* (2002)
- 142 *Operational Radiation Safety Program for Astronauts in Low-Earth Orbit: A Basic Framework* (2002)
- 143 *Management Techniques for Laboratories and Other Small Institutional Generators to Minimize Off-Site Disposal of Low-Level Radioactive Waste* (2003)
- 144 *Radiation Protection for Particle Accelerator Facilities* (2003)
- 145 *Radiation Protection in Dentistry* (2003)
- 146 *Approaches to Risk Management in Remediation of Radioactively Contaminated Sites* (2004)
- 147 *Structural Shielding Design for Medical X-Ray Imaging Facilities* (2004)

Binders for NCRP reports are available. Two sizes make it possible to collect into small binders the “old series” of reports (NCRP Reports Nos. 8–30) and into large binders the more recent publications (NCRP Reports Nos. 32–147). Each binder will accommodate from five to seven reports. The binders carry the identification “NCRP Reports” and come with label holders which permit the user to attach labels showing the reports contained in each binder.

The following bound sets of NCRP reports are also available:

- Volume I. NCRP Reports Nos. 8, 22
- Volume II. NCRP Reports Nos. 23, 25, 27, 30
- Volume III. NCRP Reports Nos. 32, 35, 36, 37
- Volume IV. NCRP Reports Nos. 38, 40, 41
- Volume V. NCRP Reports Nos. 42, 44, 46
- Volume VI. NCRP Reports Nos. 47, 49, 50, 51
- Volume VII. NCRP Reports Nos. 52, 53, 54, 55, 57
- Volume VIII. NCRP Report No. 58
- Volume IX. NCRP Reports Nos. 59, 60, 61, 62, 63
- Volume X. NCRP Reports Nos. 64, 65, 66, 67
- Volume XI. NCRP Reports Nos. 68, 69, 70, 71, 72
- Volume XII. NCRP Reports Nos. 73, 74, 75, 76
- Volume XIII. NCRP Reports Nos. 77, 78, 79, 80
- Volume XIV. NCRP Reports Nos. 81, 82, 83, 84, 85
- Volume XV. NCRP Reports Nos. 86, 87, 88, 89
- Volume XVI. NCRP Reports Nos. 90, 91, 92, 93
- Volume XVII. NCRP Reports Nos. 94, 95, 96, 97

Volume XVIII. NCRP Reports Nos. 98, 99, 100
 Volume XIX. NCRP Reports Nos. 101, 102, 103, 104
 Volume XX. NCRP Reports Nos. 105, 106, 107, 108
 Volume XXI. NCRP Reports Nos. 109, 110, 111
 Volume XXII. NCRP Reports Nos. 112, 113, 114
 Volume XXIII. NCRP Reports Nos. 115, 116, 117, 118
 Volume XXIV. NCRP Reports Nos. 119, 120, 121, 122
 Volume XXV. NCRP Report No. 123I and 123II
 Volume XXVI. NCRP Reports Nos. 124, 125, 126, 127
 Volume XXVII. NCRP Reports Nos. 128, 129, 130
 Volume XXVIII. NCRP Reports Nos. 131, 132, 133
 Volume XXIX. NCRP Reports Nos. 134, 135, 136, 137
 Volume XXX. NCRP Reports Nos. 138, 139
 Volume XXXI. NCRP Report No. 140

(Titles of the individual reports contained in each volume are given previously.)

NCRP Commentaries

No.	Title
1	<i>Krypton-85 in the Atmosphere—With Specific Reference to the Public Health Significance of the Proposed Controlled Release at Three Mile Island</i> (1980)
4	<i>Guidelines for the Release of Waste Water from Nuclear Facilities with Special Reference to the Public Health Significance of the Proposed Release of Treated Waste Waters at Three Mile Island</i> (1987)
5	<i>Review of the Publication, Living Without Landfills</i> (1989)
6	<i>Radon Exposure of the U.S. Population—Status of the Problem</i> (1991)
7	<i>Misadministration of Radioactive Material in Medicine—Scientific Background</i> (1991)
8	<i>Uncertainty in NCRP Screening Models Relating to Atmospheric Transport, Deposition and Uptake by Humans</i> (1993)
9	<i>Considerations Regarding the Unintended Radiation Exposure of the Embryo, Fetus or Nursing Child</i> (1994)
10	<i>Advising the Public about Radiation Emergencies: A Document for Public Comment</i> (1994)
11	<i>Dose Limits for Individuals Who Receive Exposure from Radionuclide Therapy Patients</i> (1995)
12	<i>Radiation Exposure and High-Altitude Flight</i> (1995)
13	<i>An Introduction to Efficacy in Diagnostic Radiology and Nuclear Medicine (Justification of Medical Radiation Exposure)</i> (1995)

- 14 *A Guide for Uncertainty Analysis in Dose and Risk Assessments Related to Environmental Contamination* (1996)
- 15 *Evaluating the Reliability of Biokinetic and Dosimetric Models and Parameters Used to Assess Individual Doses for Risk Assessment Purposes* (1998)
- 16 *Screening of Humans for Security Purposes Using Ionizing Radiation Scanning Systems* (2003)
- 17 *Pulsed Fast Neutron Analysis System Used in Security Surveillance* (2003)
- 18 *Biological Effects of Modulated Radiofrequency Fields* (2003)

Proceedings of the Annual Meeting

- | No. | Title |
|-----|--|
| 1 | <i>Perceptions of Risk</i> , Proceedings of the Fifteenth Annual Meeting held on March 14-15, 1979 (including Taylor Lecture No. 3) (1980) |
| 3 | <i>Critical Issues in Setting Radiation Dose Limits</i> , Proceedings of the Seventeenth Annual Meeting held on April 8-9, 1981 (including Taylor Lecture No. 5) (1982) |
| 4 | <i>Radiation Protection and New Medical Diagnostic Approaches</i> , Proceedings of the Eighteenth Annual Meeting held on April 6-7, 1982 (including Taylor Lecture No. 6) (1983) |
| 5 | <i>Environmental Radioactivity</i> , Proceedings of the Nineteenth Annual Meeting held on April 6-7, 1983 (including Taylor Lecture No. 7) (1983) |
| 6 | <i>Some Issues Important in Developing Basic Radiation Protection Recommendations</i> , Proceedings of the Twentieth Annual Meeting held on April 4-5, 1984 (including Taylor Lecture No. 8) (1985) |
| 7 | <i>Radioactive Waste</i> , Proceedings of the Twenty-first Annual Meeting held on April 3-4, 1985 (including Taylor Lecture No. 9) (1986) |
| 8 | <i>Nonionizing Electromagnetic Radiations and Ultrasound</i> , Proceedings of the Twenty-second Annual Meeting held on April 2-3, 1986 (including Taylor Lecture No. 10) (1988) |
| 9 | <i>New Dosimetry at Hiroshima and Nagasaki and Its Implications for Risk Estimates</i> , Proceedings of the Twenty-third Annual Meeting held on April 8-9, 1987 (including Taylor Lecture No. 11) (1988) |
| 10 | <i>Radon</i> , Proceedings of the Twenty-fourth Annual Meeting held on March 30-31, 1988 (including Taylor Lecture No. 12) (1989) |
| 11 | <i>Radiation Protection Today—The NCRP at Sixty Years</i> , Proceedings of the Twenty-fifth Annual Meeting held on April 5-6, 1989 (including Taylor Lecture No. 13) (1990) |

- 12 *Health and Ecological Implications of Radioactively Contaminated Environments*, Proceedings of the Twenty-sixth Annual Meeting held on April 4-5, 1990 (including Taylor Lecture No. 14) (1991)
- 13 *Genes, Cancer and Radiation Protection*, Proceedings of the Twenty-seventh Annual Meeting held on April 3-4, 1991 (including Taylor Lecture No. 15) (1992)
- 14 *Radiation Protection in Medicine*, Proceedings of the Twenty-eighth Annual Meeting held on April 1-2, 1992 (including Taylor Lecture No. 16) (1993)
- 15 *Radiation Science and Societal Decision Making*, Proceedings of the Twenty-ninth Annual Meeting held on April 7-8, 1993 (including Taylor Lecture No. 17) (1994)
- 16 *Extremely-Low-Frequency Electromagnetic Fields: Issues in Biological Effects and Public Health*, Proceedings of the Thirtieth Annual Meeting held on April 6-7, 1994 (not published).
- 17 *Environmental Dose Reconstruction and Risk Implications*, Proceedings of the Thirty-first Annual Meeting held on April 12-13, 1995 (including Taylor Lecture No. 19) (1996)
- 18 *Implications of New Data on Radiation Cancer Risk*, Proceedings of the Thirty-second Annual Meeting held on April 3-4, 1996 (including Taylor Lecture No. 20) (1997)
- 19 *The Effects of Pre- and Postconception Exposure to Radiation*, Proceedings of the Thirty-third Annual Meeting held on April 2-3, 1997, *Teratology* **59**, 181–317 (1999)
- 20 *Cosmic Radiation Exposure of Airline Crews, Passengers and Astronauts*, Proceedings of the Thirty-fourth Annual Meeting held on April 1-2, 1998, *Health Phys.* **79**, 466–613 (2000)
- 21 *Radiation Protection in Medicine: Contemporary Issues*, Proceedings of the Thirty-fifth Annual Meeting held on April 7-8, 1999 (including Taylor Lecture No. 23) (1999)
- 22 *Ionizing Radiation Science and Protection in the 21st Century*, Proceedings of the Thirty-sixth Annual Meeting held on April 5-6, 2000, *Health Phys.* **80**, 317–402 (2001)
- 23 *Fallout from Atmospheric Nuclear Tests—Impact on Science and Society*, Proceedings of the Thirty-seventh Annual Meeting held on April 4-5, 2001, *Health Phys.* **82**, 573–748 (2002)
- 24 *Where the New Biology Meets Epidemiology: Impact on Radiation Risk Estimates*, Proceedings of the Thirty-eighth Annual Meeting held on April 10-11, 2002, *Health Phys.* **85**, 1–108 (2003)
- 25 *Radiation Protection at the Beginning of the 21st Century—A Look Forward*, Proceedings of the Thirty-ninth Annual Meeting held on April 9–10, 2003, *Health Phys.* **87**, 237–319 (2004)

Lauriston S. Taylor Lectures

No.	Title
1	<i>The Squares of the Natural Numbers in Radiation Protection</i> by Herbert M. Parker (1977)
2	<i>Why be Quantitative about Radiation Risk Estimates?</i> by Sir Edward Pochin (1978)
3	<i>Radiation Protection—Concepts and Trade Offs</i> by Hymer L. Friedell (1979) [available also in <i>Perceptions of Risk</i> , see above]
4	<i>From “Quantity of Radiation” and “Dose” to “Exposure” and “Absorbed Dose”—An Historical Review</i> by Harold O. Wyckoff (1980)
5	<i>How Well Can We Assess Genetic Risk? Not Very</i> by James F. Crow (1981) [available also in <i>Critical Issues in Setting Radiation Dose Limits</i> , see above]
6	<i>Ethics, Trade-offs and Medical Radiation</i> by Eugene L. Saenger (1982) [available also in <i>Radiation Protection and New Medical Diagnostic Approaches</i> , see above]
7	<i>The Human Environment—Past, Present and Future</i> by Merrill Eisenbud (1983) [available also in <i>Environmental Radioactivity</i> , see above]
8	<i>Limitation and Assessment in Radiation Protection</i> by Harald H. Rossi (1984) [available also in <i>Some Issues Important in Developing Basic Radiation Protection Recommendations</i> , see above]
9	<i>Truth (and Beauty) in Radiation Measurement</i> by John H. Harley (1985) [available also in <i>Radioactive Waste</i> , see above]
10	<i>Biological Effects of Non-ionizing Radiations: Cellular Properties and Interactions</i> by Herman P. Schwan (1987) [available also in <i>Nonionizing Electromagnetic Radiations and Ultrasound</i> , see above]
11	<i>How to be Quantitative about Radiation Risk Estimates</i> by Seymour Jablon (1988) [available also in <i>New Dosimetry at Hiroshima and Nagasaki and its Implications for Risk Estimates</i> , see above]
12	<i>How Safe is Safe Enough?</i> by Bo Lindell (1988) [available also in <i>Radon</i> , see above]
13	<i>Radiobiology and Radiation Protection: The Past Century and Prospects for the Future</i> by Arthur C. Upton (1989) [available also in <i>Radiation Protection Today</i> , see above]
14	<i>Radiation Protection and the Internal Emitter Saga</i> by J. Newell Stannard (1990) [available also in <i>Health and Ecological Implications of Radioactively Contaminated Environments</i> , see above]
15	<i>When is a Dose Not a Dose?</i> by Victor P. Bond (1992) [available also in <i>Genes, Cancer and Radiation Protection</i> , see above]

- 16 *Dose and Risk in Diagnostic Radiology: How Big? How Little?* by Edward W. Webster (1992) [available also in *Radiation Protection in Medicine*, see above]
- 17 *Science, Radiation Protection and the NCRP* by Warren K. Sinclair (1993) [available also in *Radiation Science and Societal Decision Making*, see above]
- 18 *Mice, Myths and Men* by R.J. Michael Fry (1995)
- 19 *Certainty and Uncertainty in Radiation Research* by Albrecht M. Kellerer. Health Phys. **69**, 446–453 (1995)
- 20 *70 Years of Radiation Genetics: Fruit Flies, Mice and Humans* by Seymour Abrahamson. Health Phys. **71**, 624–633 (1996)
- 21 *Radionuclides in the Body: Meeting the Challenge* by William J. Bair. Health Phys. **73**, 423–432 (1997)
- 22 *From Chimney Sweeps to Astronauts: Cancer Risks in the Work Place* by Eric J. Hall. Health Phys. **75**, 357–366 (1998)
- 23 *Back to Background: Natural Radiation and Radioactivity Exposed* by Naomi H. Harley. Health Phys. **79**, 121–128 (2000)
- 24 *Administered Radioactivity: Unde Venimus Quoquo Imus* by S. James Adelstein. Health Phys. **80**, 317–324 (2001)
- 25 *Assuring the Safety of Medical Diagnostic Ultrasound* by Wesley L. Nyborg. Health Phys. **82**, 578–587 (2002)
- 26 *Developing Mechanistic Data for Incorporation into Cancer and Genetic Risk Assessments: Old Problems and New Approaches* by R. Julian Preston. Health Phys. **85**, 4–12 (2003)
- 27 *The Evolution of Radiation Protection—From Erythema to Genetic Risks to Risks of Cancer to ?* by Charles B. Meinhold, Health Phys. **87**, 240–248 (2004)

Symposium Proceedings

- | No. | Title |
|-----|--|
| 1 | <i>The Control of Exposure of the Public to Ionizing Radiation in the Event of Accident or Attack</i> , Proceedings of a Symposium held April 27-29, 1981 (1982) |
| 2 | <i>Radioactive and Mixed Waste—Risk as a Basis for Waste Classification</i> , Proceedings of a Symposium held November 9, 1994 (1995) |
| 3 | <i>Acceptability of Risk from Radiation—Application to Human Space Flight</i> , Proceedings of a Symposium held May 29, 1996 (1997) |
| 4 | <i>21st Century Biodosimetry: Quantifying the Past and Predicting the Future</i> , Proceedings of a Symposium held February 22, 2001, Radiat. Prot. Dosim. 97 (1), (2001) |

- 5 *National Conference on Dose Reduction in CT, with an Emphasis on Pediatric Patients*, Summary of a Symposium held November 6-7, 2002, Am. J. Roentgenol. **181**(2), 321–339 (2003)

NCRP Statements

No.	Title
1	“Blood Counts, Statement of the National Committee on Radiation Protection,” <i>Radiology</i> 63 , 428 (1954)
2	“Statements on Maximum Permissible Dose from Television Receivers and Maximum Permissible Dose to the Skin of the Whole Body,” Am. J. Roentgenol., Radium Ther. and Nucl. Med. 84 , 152 (1960) and <i>Radiology</i> 75 , 122 (1960)
3	<i>X-Ray Protection Standards for Home Television Receivers, Interim Statement of the National Council on Radiation Protection and Measurements</i> (1968)
4	<i>Specification of Units of Natural Uranium and Natural Thorium, Statement of the National Council on Radiation Protection and Measurements</i> (1973)
5	<i>NCRP Statement on Dose Limit for Neutrons</i> (1980)
6	<i>Control of Air Emissions of Radionuclides</i> (1984)
7	<i>The Probability That a Particular Malignancy May Have Been Caused by a Specified Irradiation</i> (1992)
8	<i>The Application of ALARA for Occupational Exposures</i> (1999)
9	<i>Extension of the Skin Dose Limit for Hot Particles to Other External Sources of Skin Irradiation</i> (2001)

Other Documents

The following documents of the NCRP were published outside of the NCRP report, commentary and statement series:

- Somatic Radiation Dose for the General Population*, Report of the Ad Hoc Committee of the National Council on Radiation Protection and Measurements, 6 May 1959, *Science* **131** (3399), February 19, 1960, 482–486
- Dose Effect Modifying Factors in Radiation Protection*, Report of Subcommittee M-4 (Relative Biological Effectiveness) of the National Council on Radiation Protection and Measurements, Report BNL 50073 (T-471) (1967) Brookhaven National Laboratory (National Technical Information Service, Springfield, Virginia)

Index

- Adjacent areas 8, 25–26, 29–32, 74, 102–103, 106, 109
- Air kerma 1–3, 6–7, 29, 33, 42–43, 45–48, 70–71, 125–127
- as a function of operating potential 125–126
 - forward- and backscattered 46–47
 - leakage 46–47
 - limits for radiographic films 7
 - primary beam per unit workload 125–127
 - relationship to effective dose 3
 - resources for unshielded air kerma in Report 70–71
 - scattered 46–48
 - side-scattered 46–47
 - total secondary air kerma 46–47
 - unshielded air kerma 46–47
 - unshielded leakage air kerma 45–46
 - unshielded primary air kerma 42–43
 - unshielded secondary air kerma 45, 48
- ALARA (as low as reasonably achievable) principle 8, 25–26, 69
- American Association of Physicists in Medicine 32–38, 46
- survey of clinical sites 32–38, 46
- American Board of Health Physics 7
- American Board of Medical Physics 7
- American Board of Radiology 7
- American College of Radiology 98–99
- American Society for Testing and Materials 24
- Architects 1, 17–18, 20, 22–23, 25, 27–28, 103, 106, 112–113
- and construction standards 23
 - and exterior walls 18
 - and shielding design 25, 27–28
 - and shielding materials 17
 - and survey reports 112–113
- Attenuation coefficient 45
- Barrier thickness 54–67
- determined from lead and concrete requirements 67
 - primary radiation, concrete 57–58, 64–65
 - primary radiation, lead 54–55, 61–62
 - secondary radiation, concrete 59, 66
 - secondary radiation, lead 56, 63
- Bone mineral density units 15, 101–102
- sample shielding calculation 101–102
 - shielding considerations 102
- Bremsstrahlung 38
- Canadian College of Physicists in Medicine 7
- Cardiac angiography workload distribution 71–72, 125, 141–146
- sample calculation for secondary wall 72
 - secondary transmission, concrete 142
 - secondary transmission, gypsum wallboard 143

- secondary transmission, lead 141
- secondary transmission, plate glass 145
- secondary transmission, steel 144
- secondary transmission, wood 146
- Cardiac catheterization 12
- Ceiling 56, 58–59, 63, 66, 78
 - secondary barrier thickness, concrete 59, 66
 - secondary barrier thickness, lead 56, 63
- Chest bucky 11
- Chest image receptor 41, 79–81
 - wall 79–81
 - use factor 41
- Chest room workload distribution 128–132, 141–146
 - primary transmission, concrete 129
 - primary transmission, gypsum wallboard 130
 - primary transmission, lead 128
 - primary transmission, plate glass 132
 - primary transmission, steel 131
 - secondary transmission, concrete 142
 - secondary transmission, gypsum wallboard 143
 - secondary transmission, lead 141
 - secondary transmission, plate glass 145
 - secondary transmission, steel 144
 - secondary transmission, wood 146
- Cine radiography 12
- Computed tomography 14, 30, 71, 94–101, 111–112, 117, 123–124
 - computed tomography dose index 95–97
 - dosimetry phantoms 94
 - default dose-length-product values 99
 - dose-length product 95, 97–100
 - dose-line integral 95
 - installations 14
 - isodose map method 100
 - pitch 94
 - sample calculation, computed tomography dose index 96–100
 - sample calculation, dose-length product 99–100
 - scanner survey 111–112
 - scatter fraction per centimeter 96
 - summary of resources in Report 71
 - secondary barriers 14
 - transmission of secondary radiation 117, 123–124
- Concrete 20–21, 44, 50, 57–60, 64–67, 70–71, 118–119, 121–124, 129, 133–134, 140, 142, 147–148, 150
 - fitting parameters, primary x rays, by kVp 118–119
 - fitting parameters, primary x rays, by workload distribution 133
 - fitting parameters, secondary radiation, by kVp and workload distribution 147–148
- floor slab construction 21
- half-value layer at high attenuation 122
- light-weight 21
- presheilding 44
- primary barrier thickness 57–58, 64–65
- primary transmission, by workload distribution 129
- secondary barrier thickness 59, 66
- secondary transmission, by workload distribution 142
- secondary transmission and fitting parameters, computed tomography 124

- standard-weight 20–21
- summary of resources in Report 70–71
- Construction standards 23
- Controlled area 2, 3–4, 29, 31
 - recommended effective dose 4
 - shielding design goal 3–4
- Corridors 16, 25–26, 30–31, 93–94, 102, 113
 - corridor doors 31
- Cross-table wall 41, 51–55, 57–58, 61–62, 64–65, 83, 110
 - primary barrier thickness, concrete 57–58, 64–65
 - primary barrier thickness, lead 54–55, 61–62
 - use factor 41
- Darkroom 7, 22, 81–83, 103
 - wall 22, 81–83, 103
- Dedicated chest installations 13, 51, 71, 73–74, 125
 - primary barrier 13
 - secondary barrier 13
 - sample calculation, wall adjacent to the image receptor 74
 - sample calculation, wall behind the image receptor 73–74
 - summary of resources in Report 71
- Dental x-ray facilities 15
- Digital radiography 12, 39
- Distance to the occupied area 29
- Doors 18–19
 - interlocks 19
 - lead-lined 18–19
 - mineral core 18
 - wooden 18
- Dose limits 3–5
 - effective dose limit, members of the public 4–5
 - effective dose limit, radiation workers 4
 - equivalent dose limit, embryo or fetus, pregnant radiation worker 4
- Effective dose 2, 3–5, 93, 113
 - limits 3–5
 - recommendations for controlled and uncontrolled areas 4–5
 - relationship to air kerma 3
- Embryo or fetus 4
 - equivalent dose limit, pregnant radiation worker 4
- Employees 1, 3, 4, 29–31, 79, 104
- Equivalent dose 2, 4
 - limit, embryo or fetus, pregnant radiation worker 4
- Exposure 2
- Exposure switch 11
- Exterior walls 18
- Facility administrators 1, 31–32, 98–99, 103, 114
- Federal agencies 8, 28, 104
- Film cassettes 7, 11, 43, 81, 85–86
- Film-reading rooms 3, 31
- Film-screen storage 86
- Fitting parameters 50, 117–121, 123–125
 - computed tomography 123–124
 - molybdenum anode and filter x-ray beams 117, 118, 120
 - three-phase aluminum filter, tungsten anode x-ray beams 118–121
- Floors 41, 54–59, 61–66, 76–78
 - primary barrier thickness, concrete 57–58, 64–65
 - primary barrier thickness, lead 54–55, 61–62
 - secondary barrier thickness, concrete 59, 66
 - secondary barrier thickness, lead 56, 63
 - use factor 41
- Floors and ceilings 20–22
 - concrete 20–21
 - floor-to-floor heights 21–22
 - interstitial space 22
- Fluoroscopic installations 11–12
- Fluoroscopy 11–12, 14, 41–42, 51, 60, 86, 105, 125

- C-arm units 14, 51, 105
- installations 11–12
- x-ray tube focal spot 60
- Fluoroscopic tube (radiographic and fluoroscopic room) workload distribution 141–146
- secondary transmission, concrete 142
- secondary transmission, gypsum wallboard 143
- secondary transmission, lead 141
- secondary transmission, plate glass 145
- secondary transmission, steel 144
- secondary transmission, wood 146
- Food and Drug Administration 6, 94
- computed tomography dosimetry phantoms 94
- Forward- and backscattered radiation 46–47, 139
- Geiger-Mueller detector 105, 150–151
- Gypsum wallboard 13, 16–18, 24, 50, 60, 67, 93, 106, 114, 116, 118–119, 122, 127, 130, 133, 140, 143, 147–148
- fitting parameters, primary x rays, by kVp 118–119
- fitting parameters, primary x rays, by workload distribution 133
- fitting parameters, secondary radiation, by kVp and workload distribution 147–148
- half-value layer at high attenuation 122
- nominal thicknesses and tolerances 24
- primary transmission by workload distribution 130
- secondary transmission by workload distribution 143
- Type X 17, 24, 130, 143
- voids 17
- Half-value layer 45, 91, 102, 116–118, 122, 139, 150
- Ionization chambers 149–150
- Intensifying screens 7
- Interior walls 16–17
- gypsum wallboard 16–17
- lead 16
- other materials 17
- International System of Units 2
- Interventional facilities 12–13
- Interventional procedures 67
- Lead 6, 16–18, 23–24, 38–39, 44, 50, 54–56, 61–63, 67, 70–71, 116, 118–119, 122–123, 127–128, 133, 140–141, 147–148, 150
- fitting parameters, primary x rays, by kVp 118–119
- fitting parameters, primary x rays, by workload distribution 133
- fitting parameters, secondary radiation, by kVp and workload distribution 147–148
- half-value layer at high attenuation 122
- joints between lead sheets 23
- nominal thicknesses and tolerances 24
- preshielding 44
- primary barrier thickness 54–55, 61–62
- primary transmission 38–39, 116, 127
- primary transmission, by workload distribution 128
- relative cost per sheet (standard thicknesses) 16–17
- secondary barrier thickness 56, 63
- secondary transmission, by workload distribution 141
- standard thicknesses 6

- summary of resources in Report 70–71
- transmission (and fitting parameters), secondary radiation, computed tomography 123
- Lead acrylic 13, 20, 116
- Lead aprons 5
- Lead curtains 5
- Lead glass 13, 20
- Leakage radiation 5–6, 10, 33, 42, 45–48, 116, 138–139
 - technique factors 5–6, 45
 - model for predicting leakage air kerma 138–139
 - regulatory limit 45, 138
 - transmission 116
- Local agencies 8, 19, 28, 104
- Mammographic installations 13–14, 18
 - primary barrier 13
 - secondary barrier 13
- Mammography 7, 17, 39, 41–42, 46, 71, 91–94, 116, 125, 135, 137
 - digital 39
 - sample calculation, adjacent wall 92–93
 - sample calculation, opposite wall 93
 - scatter fraction 137
 - secondary radiation 135
 - shielding conclusions 93–94
 - summary of resources in Report 71
 - transmission 116
 - unshielded air kerma 92
- Mammography room workload distribution 141–146
 - secondary transmission, concrete 142
 - secondary transmission, gypsum wallboard 143
 - secondary transmission, lead 141
 - secondary transmission, plate glass 145
- secondary transmission, steel 144
- secondary transmission, wood 146
- Maximally exposed individual 29, 30, 50, 51
- Medical x-ray imaging facilities 10–15, 42
 - dedicated chest installations 13
 - fluoroscopic installations 11
 - interventional facilities 12
 - mammographic installations 13
 - mobile or portable x-ray units 14
 - other x-ray imaging systems 15
 - radiographic installations 10–11
 - x-ray room layout 42
- Members of the public 1, 3–4, 29, 74, 104
- Molybdenum anode and filter x-ray tubes 125–126
 - air kerma per unit workload 125–126
 - in mammography 125–126
- Mobile x-ray units 13–14
 - bone mineral density units 14
 - C-arm fluoroscopes 14
 - mammographic 13–14
 - radiographic 14
- Monte Carlo calculations 117
- Monitoring 3
- Neuroangiography suites 12
- Neuroangiography workload distribution 71, 125, 141–146
 - secondary transmission, concrete 142
 - secondary transmission, gypsum wallboard 143
 - secondary transmission, lead 141
 - secondary transmission, plate glass 145
 - secondary transmission, steel 144
 - secondary transmission, wood 146
 - summary of resources in Report 71

- Occupancy factors 6, 22, 29–32, 38, 49–51, 76, 78–79, 90, 93, 103–104, 106, 110
 - building adjacent to an x-ray facility 31–32
 - controlled areas 31
 - definition 29–30
 - suggested occupancy factors 31
 - x-ray control booths 31
- Other x-ray imaging systems 15
- Patient attenuation 44–45
- Peripheral angiography workload
 - distribution 12, 71, 125, 141–146
 - secondary transmission, concrete 142
 - secondary transmission, gypsum wallboard 143
 - secondary transmission, lead 141
 - secondary transmission, plate glass 145
 - secondary transmission, steel 144
 - secondary transmission, wood 146
 - summary of resources in Report 71
- Phantoms 105, 107–108, 112, 135
- Placards 28, 115
- Plate glass 20, 24, 50, 60, 67, 103, 116–118, 120–122, 127, 132, 134, 140, 145, 147–148
 - fitting parameters, primary x rays, by kVp 120–121
 - fitting parameters, primary x rays, by workload distribution 134
- fitting parameters, secondary radiation, by kVp and workload distribution 147–148
 - half-value layer at high attenuation 122
 - nominal thicknesses and tolerances 24
 - primary transmission, by workload distribution 132
 - secondary transmission, by workload distribution 145
- Preshielding 43–45, 50, 54–55, 57–58, 61–62, 64–65, 73, 83–84, 89, 111, 129
 - by the imaging hardware 43–45, 73, 83
 - by the patient 43–45
 - concrete 44
 - lead 44
 - minimum equivalent thickness 44
 - steel 44
- Primary barrier 9, 11, 13, 23, 41–45, 50, 125–134
 - computation of thickness 125–134
 - definition 41
 - fluoroscopic installations 11
 - joints between lead sheets 23
 - preshielding 43–45
 - radiographic installations 11
- Primary beam 5, 42, 125
 - definition 125
- Primary beam stops 41–42, 72, 91, 125, 135
 - angiography (cardiac, neuro-, peripheral) 42
 - fluoroscopy 42
 - mammography 42
- Primary beam transmission curves 50
- Primary radiation 9–10
- Primary transmission data for workload distributions 128–132
 - through concrete 129
 - through gypsum 130
 - through lead 128
 - through plate glass 132
 - through steel 131
- Problem abatement for inadequate shielding 113–115
 - additional shielding 114
 - minor problems 113
 - restrictions on use 114

- Qualified expert (and role in items listed below) 7–8, 11, 13–15, 17–20, 22–23, 25, 27–28, 30–31, 39–41, 44–45, 69, 74, 76, 84, 93–94, 99, 101, 103–106, 112–113, 127
 adjusted workload per patient (site specific) 39
 bone mineral density units 15
 computed tomography 99, 101
 construction standards 23
 evaluating the shielding
 adequacy 106
 exterior walls 18
 floor systems 20
 fluoroscopic rooms 11
 integrity of barriers 22
 interlocks, warning lights, warning signs 18
 mammography 13, 93
 mobile x-ray units 14
 number of patients 127
 occupancy factors 30–31
 penetrations in barriers 22
 performance assessments 74
 preshielding 44–45
 radiation protection surveys 104
 shielding design 25, 27, 28
 shielding design report 103
 shielding parameters 76
 survey report 112–113
 use factors 41
 voids or openings in shielded barriers 104–106
 wooden doors 94
 workload per patient 39
- Radiation protection surveys 8, 28, 69, 102, 104–115, 149–157
 documentation 115
 inspection for voids 104–106
 problem abatement 113–115
 shielding adequacy 106–112
 survey reports 28, 112–113
- Radiation quantities 1–2
 air kerma 1–2
 effective dose 2
 equivalent dose 2
 exposure 2
- Radiation weighting factor 2
- Radiation workers 3–4, 31
- Radioactive materials license 105
- Radiographic and fluoroscopic room 53, 60–68, 70, 75, 86–91, 125
 barrier thickness, primary, concrete 64–65
 barrier thickness, primary, lead 61–62
 elevation drawing or view 53, 75
 plan drawing or view 53, 75
 sample calculation, floor, primary barrier 89–91
 sample calculation, floor, secondary barrier 87–89
 barrier thickness, secondary, concrete 66
 barrier thickness, secondary, lead 63
 summary of resources in Report 70
- Radiographic installations 10–11
- Radiographic rooms 51, 53, 54–59, 70, 74–86, 125
 barrier thickness, primary, concrete 57–58
 barrier thickness, primary, lead 54–55
 barrier thickness, secondary, concrete 59
 barrier thickness, secondary, lead 56
 elevation drawing or view 75
 plan drawing or view 53, 75
 sample calculation, ceiling 78–79
 sample calculation, x-ray control booth wall 85–86
 sample calculation, cross-table wall 83–84
 sample calculation, darkroom wall 81–83
 sample calculation, floor, primary barrier 76–77

- sample calculation, floor, secondary barrier 77–78
- sample calculation, wall containing image receptor, primary barrier 79–80
- sample calculation, wall containing image receptor, secondary barrier 80–81
- summary of resources in Report 70
- Radionuclide sources 105
- Radiographic room (all barriers) workload distribution 128–132, 141–146
 - primary transmission, concrete 129
 - primary transmission, gypsum wallboard 130
 - primary transmission, lead 128
 - primary transmission, plate glass 132
 - primary transmission, steel 131
 - secondary transmission, concrete 142
 - secondary transmission, gypsum wallboard 143
 - secondary transmission, lead 141
 - secondary transmission, plate glass 145
 - secondary transmission, steel 144
 - secondary transmission, wood 146
- Radiographic room (chest bucky) workload distribution 128–132, 141–146
 - primary transmission, concrete 129
 - primary transmission, gypsum wallboard 130
 - primary transmission, lead 128
 - primary transmission, plate glass 132
 - primary transmission, steel 131
 - secondary transmission, concrete 142
- secondary transmission, gypsum wallboard 143
- secondary transmission, lead 141
- secondary transmission, plate glass 145
- secondary transmission, steel 144
- secondary transmission, wood 146
- Radiographic tube (radiographic and fluoroscopic room) workload distribution 128–132, 141–146
 - primary transmission, concrete 129
 - primary transmission, gypsum wallboard 130
 - primary transmission, lead 128
 - primary transmission, plate glass 132
 - primary transmission, steel 131
 - secondary transmission, concrete 142
- secondary transmission, gypsum wallboard 143
- secondary transmission, lead 141
- secondary transmission, plate glass 145
- secondary transmission, steel 144
- secondary transmission, wood 146

- secondary transmission, gypsum wallboard 143
- secondary transmission, lead 141
- secondary transmission, plate glass 145
- secondary transmission, steel 144
- secondary transmission, wood 146
- Relative biological effectiveness 2
- Relative cost of sheet lead (standard thicknesses) 16–17
- Scatter fraction 48, 135–138
 - as a function of kVp 137
 - as a function of scattering angle 137
 - for molybdenum anode and filter x-ray beams 137
 - for tungsten anode, aluminum filter x-ray beams 137
- Scattered radiation 6, 10, 42, 48, 135–138
- Scintillation detector 105, 151
- Secondary barriers 9–11, 13, 22–23, 45–48, 51, 135–148
 - computation by iteration of barrier thickness 145–146
 - computation of thickness 135–148
 - definition 45
 - fluoroscopic installations 11
 - general computation case, multiple x-ray sources 142–145
 - joints between lead sheets 23
 - leakage radiation 45–48
 - penetrations 22
 - scattered radiation 45–48
- Secondary radiation 9–10, 48, 135, 139–142
 - forward- and backscattered 48
 - side-scattered 48
- Secondary transmission data for workload distributions 141–146
 - through concrete 142
 - through gypsum 143
 - through lead 141
 - through plate glass 145
 - through steel 144
 - through wood 146
- Secondary wall 56, 59, 63, 66
 - barrier thickness, concrete 59, 66
 - barrier thickness, lead 56, 63
- Shielding adequacy 106–112
 - sample evaluation, computed tomography 111–112
 - sample evaluation, cross-table wall 110
 - sample evaluation, floor 111
 - sample evaluation, chest bucky wall, primary barrier 109–110
 - sample evaluation, chest bucky wall, secondary barrier 110
 - sample evaluation, secondary barrier (no primary beam possible) 110–111
 - transmission measurements 107–111
 - visual inspection in mid-construction 106–107
- Shielding calculations (methods and data) 49–68
 - barrier transmission factor 51
 - by algebraic determination 50–51
 - general shielding concepts 49
 - primary barriers 50
 - primary beam transmission functions 50
 - radiographic and fluoroscopic rooms 51
 - radiographic rooms 51–60
 - secondary barriers 51
- Shielding calculations (examples) 69–103
 - bone mineral density units 101–102
 - cardiac angiography 72
 - computed tomography 96–97, 99–100
 - dedicated chest unit 73–74
 - mammography 92–94

- radiographic and fluoroscopic room 86–91
- radiographic room 74–86
- Shielding design assumptions 5–7
 - angle of radiation incidence 5
 - distance to the occupied area 6
 - leakage radiation 5–6
 - occupancy factors 6
 - patient attenuation 5
 - presence of additional shielding devices 5
 - radiation incidence 5
 - scattered radiation 6
 - standard lead thicknesses 6
- Shielding design goals 3–5, 7–9, 29, 49–51, 69, 102, 104, 106, 112, 143
- Shielding design process 25–28
 - construction document preparation 28
 - design development 27
 - documentation 28
 - programming 27
 - project development 25–28
 - schematic (preliminary) design 27
 - strategic budgeting 26
 - strategic planning 25
- Shielding design report 103
- Side-scattered radiation 46–47, 139
- State agencies 8, 16, 19, 28, 103–104
- Steel 20–22, 24, 44, 50, 60, 67, 103, 116, 120–122, 127, 131, 134, 140, 144, 147–148
 - fitting parameters, primary x rays, by kVp 120–121
 - fitting parameters, primary x rays, by workload distribution 134
 - fitting parameters, secondary radiation, by kVp and workload distribution 147–148
 - half-value layer at high attenuation 122
 - nominal thicknesses and tolerances 24
 - primary transmission, by workload distribution 131
 - preshielding 44
 - secondary transmission, by workload distribution 144
- Summary of resources in Report 70–71
 - for concrete 70–71
 - for lead 70–71
 - for other materials 70–71
- Survey instruments 2, 106
- Tissue weighting factor 2
- Transmission of x rays 5–7, 38, 49, 70–71, 116–124
 - data, by kVp , concrete 118–119
 - data, by kVp , gypsum wallboard 118–119
 - data, by kVp , lead 118–119, 123
 - data, by kVp , plate glass 120–121
 - data, by kVp , steel 120–121
 - data, by kVp , wood 120–121
 - data, resources in Report 70–71
 - effect of shielding design assumptions 5–7
 - fitting parameters 49
 - primary beam curve, example for lead 38
- Tungsten anode, aluminum filter x-ray tubes 125–126
 - air kerma per unit workload 125–126
- Uncontrolled areas 2–5, 29
 - areas adjacent to an x-ray facility 4
 - recommended effective dose 4–5
 - shielding design goal 3–5
- Underwriters Laboratories, Inc. 16
- Use factors 33, 39–41, 49–50, 52, 55, 73, 76, 79, 83, 106
 - dependence on type of x-ray installation 39–40
 - definition 39–40

- for fluoroscopy 41
 - for a general radiographic room 41
 - for mammography 41
- Veterinary x-ray facilities 15
- Voids in shielding materials 13, 17–18, 21, 104–106, 150
- Warning lights and signs 19
- Windows 19–20
 - lead acrylic 20
 - lead glass 20
 - plate glass 20
- Wood 13, 18–19, 93, 103, 116–118, 120–122, 124, 134, 140, 146–148
 - fitting parameters, primary
 - x rays, by kVp 120–121
 - fitting parameters, primary
 - x rays, by workload distribution 134
 - fitting parameters, secondary
 - radiation, by kVp and workload distribution 147–148
 - half-value layer at high
 - attenuation 122
 - secondary transmission, by
 - workload distribution 146
- Wooden doors 18, 24
 - in mammography installations 18
 - nominal thicknesses and tolerances 24
- Workload 32–40, 125
 - adjusted workload per patient (site specific) 39
 - as a function of kVp 33
 - average workload per patient 32, 39
 - definition 32
 - estimated total workload per week 40
 - for a radiographic room 32
 - number of patients per week 32, 40
 - total workload per patient 40
 - total workload per week 32
- Workload distributions 32–38, 40–47, 67–68, 128–132, 141–146
 - cardiac angiography 34–38, 40, 47, 141–146
 - chest room 34–38, 40, 43, 47, 128–132, 141–146
 - comparison of radiographic room (floor or other barriers) and 100 kVp 34–38
 - fluoroscopic tube (radiographic and fluoroscopic room) 34–38, 40, 46
 - mammography room 34–38, 40, 47, 141–146
 - neuroangiography 34–38, 40, 47, 141–146
 - new imaging technologies 68
 - peripheral angiography 34–38, 40, 47, 141–146
 - prescreening data 44–45
 - radiographic room (all barriers) 34–38, 46, 141–146
 - radiographic room (chest bucky) 34–38, 40–41, 43, 46, 128–132, 141–146
 - radiographic room (floor or other barriers) 34–38, 40–41, 43, 46, 128–132, 141–146
 - radiographic tube (radiographic and fluoroscopic room) 34–38, 40, 43, 46, 128–132, 141–146
 - total workload per patient, primary radiation 42–43
 - uncertainties 67–68
 - unshielded primary air kerma 42–43
 - use factor 41
- X-ray control booth 3, 11, 12, 19, 31, 41, 85–86, 110
 - control booth wall 85–86
- X-ray film 7, 22, 81–83, 85–87, 105
- X-ray operators 11, 13, 15, 19, 27, 85, 102, 110